



[View offers](#)



[Book a test drive](#) [AMG test drive](#)



[Find a Retailer](#)



[View the Range Guide](#)

# S-Class

Saloon



Effective from 1 December 2016 Production.

Mercedes-Benz





> View offers



Book a > test drive > AMG test drive



> Find a Retailer



> View the Range Guide

# Contents

Model prices	11	Standard equipment	31	Technical data	69
Finance offers	12	Wheels	43	Road Fund Licence	73
SE and AMG Line	16	Driving Assistance package	45	Services and insurance	74
Premium and Premium Plus equipment lines	20	Rear Seat Reclining package and Individual Rear Seats package	46	Mercedes me	75
Mercedes-AMG models	22	Rear Seat Comfort package	48	Mercedes-Benz Finance	77
Executive equipment line	26	Optional equipment	50	Chargemaster Homecharge	79
Mercedes-AMG driver training	28	Genuine Accessories	63		
Pricing summary for Executive, Premium and Premium Plus equipment lines	30	Colours and materials	65		



> View offers



Book a > test drive > AMG test drive



> Find a Retailer



> View the Range Guide

## The hard facts to melt your heart

At Mercedes-Benz we appreciate the importance of detail. Over the following pages you'll find model prices and a breakdown of standard and optional equipment, as well as details of the comprehensive services and benefits that are available to every Mercedes-Benz driver.

See Mercedes-Benz in a new light. Now is the time to get yourself behind the wheel of an S-Class. Choose from a number of attractive finance offers. Please see pages 12-15 for further details, or visit [www.mercedes-benz.co.uk/offers](http://www.mercedes-benz.co.uk/offers)

Of course, some things have to be experienced to be truly appreciated, such as the qualities that set a Mercedes-Benz apart. Which is why we'd like to invite you for a test drive at your local Mercedes-Benz Retailer. Alternatively, you can make arrangements by visiting [www.mercedes-benz.co.uk/testdrive](http://www.mercedes-benz.co.uk/testdrive)

For more information visit [www.mercedes-benz.co.uk](http://www.mercedes-benz.co.uk) or call 0333 222 0500.



[View offers](#)



[Book a test drive](#) [AMG test drive](#)



[Find a Retailer](#)



[View the Range Guide](#)







> View offers



Book a > test drive > AMG test drive



> Find a Retailer



> View the Range Guide





> View offers



Book a > test drive > AMG test drive



> Find a Retailer



> View the Range Guide



Model features optional equipment at an additional cost.





> View offers



Book a > test drive > AMG test drive



> Find a Retailer



> View the Range Guide



Model features optional equipment at an additional cost.



[View offers](#)



[Book a test drive](#) [AMG test drive](#)



[Find a Retailer](#)



[View the Range Guide](#)



Model features optional equipment at an additional cost.





[View offers](#)



[Book a test drive](#) [AMG test drive](#)



[Find a Retailer](#)



[View the Range Guide](#)



Model features optional equipment at an additional cost.



[View offers](#)



[Book a test drive](#) [AMG test drive](#)



[Find a Retailer](#)



[View the Range Guide](#)





# Model prices

Engine	Model line	Transmission	CO <sub>2</sub>	Basic RRP excl. VAT (£)	Total RRP incl. VAT (£)	Road Fund Licence (£) <sup>1</sup>	Rec. OTR price (£) <sup>2</sup>	P11D value (£)	BiK tax rate 2016/17 (%)
<b>S 300 h</b> Diesel – 2,143 cc, 4-cylinder, 204 hp/150 kW Electric motor – 27 hp/20 kW	AMG Line L	7G-TRONIC PLUS 7-speed automatic	120	61,941.67	74,330.00	0.00	75,000.00	74,945.00	21
<b>S 350 d</b> Diesel – 2,987 cc, 6-cylinder, 258 hp/190 kW	AMG Line	9G-TRONIC PLUS 9-speed automatic	146	58,304.17	69,965.00	145.00	70,780.00	70,580.00	29
	SE L	9G-TRONIC PLUS 9-speed automatic	141	57,337.50	68,805.00	145.00	69,620.00	69,420.00	28
	AMG Line L	9G-TRONIC PLUS 9-speed automatic	148	60,637.50	72,765.00	145.00	73,580.00	73,380.00	29
<b>S 500 e</b> Petrol – 2,996 cc, 6-cylinder, 333 hp/245 kW Electric motor – 116 hp/85 kW	AMG Line L	7G-TRONIC PLUS 7-speed automatic	65	75,204.17	90,245.00	0.00	90,915.00	90,860.00	11
<b>S 500</b> Petrol – 4,663 cc, 8-cylinder, 455 hp/335 kW	AMG Line L	9G-TRONIC PLUS 9-speed automatic	196	75,087.50	90,105.00	500.00	91,275.00	90,720.00	36
<b>S 600</b> Petrol – 5,980 cc, 12-cylinder, 530 hp/390 kW	AMG Line L	7G-TRONIC PLUS 7-speed automatic	268	118,754.17	142,505.00	1,120.00	144,295.00	143,120.00	37
<b>Mercedes-AMG</b>									
<b>Mercedes-AMG S 63</b> Petrol – 5,461 cc, 8-cylinder, 585 hp/430 kW	-	AMG SPEEDSHIFT MCT 7-speed automatic	237	101,491.67	121,790.00	885.00	123,345.00	122,405.00	37
<b>Mercedes-AMG S 65</b> Petrol – 5,980 cc, 12-cylinder, 630 hp/463 kW	-	AMG SPEEDSHIFT PLUS 7G-TRONIC 7-speed auto.	279	152,100.00	182,520.00	1,120.00	184,310.00	183,135.00	37

<sup>1</sup>A different first year rate of Vehicle Excise Duty (Road Fund Licence) applies for new cars. Please refer to page 73 for the relevant rate for the second and subsequent years.

<sup>2</sup>Recommended on-the-road price: these prices reflect the Road Fund Licence applicable to the standard model plus £670.00 additional costs necessary to put your car on the road. Included are a standard UK delivery charge (£540.00 incl. VAT), new vehicle registration fee (£55.00), number plates (£25.00 incl. VAT) and fuel (£50.00 incl. VAT). VAT is calculated at the standard rate of 20%.



# Mercedes-Benz Finance

It comes with a specification list worth exploring

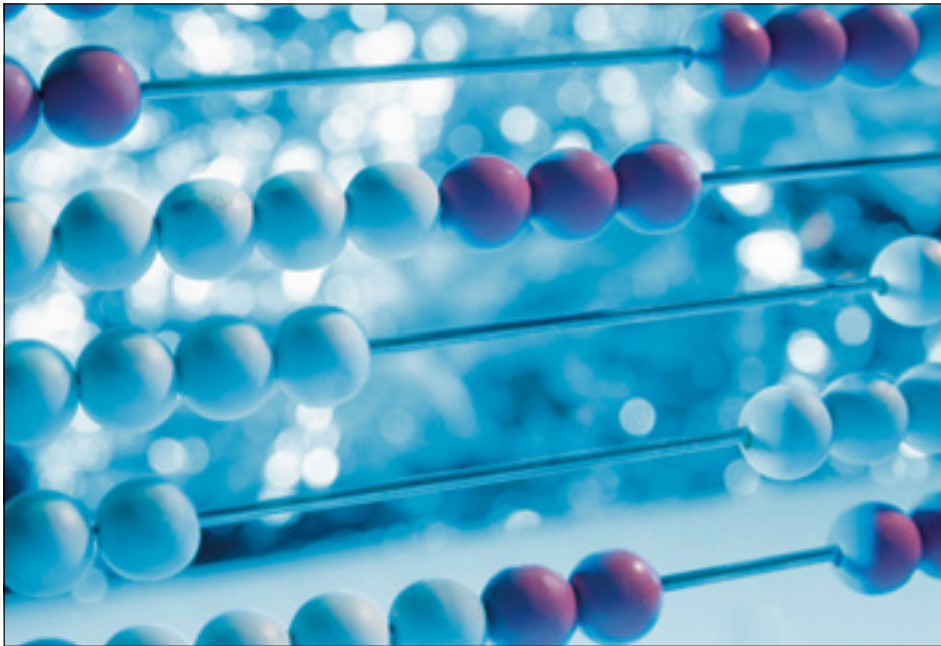

## S 350 d AMG Line Saloon (representative example)

36 monthly payments of <sup>1</sup>	£549.00
Customer deposit	£9,999.00
On-the-road price	£70,030.00
Retailer deposit contribution	£16,841.39
Optional purchase payment <sup>2</sup>	£28,500.00
Amount of credit	£43,189.61
Duration of agreement	36 months
Total amount payable <sup>3</sup>	£75,114.39
Purchase activation fee <sup>2</sup>	£10.00
APR	4.8%
Fixed interest rate	4.67%
Excess mileage	16p per mile





### Example offers – 4.8% APR Representative

	Automatic	Metallic	On-the-road price	Retailer deposit contribution	Customer deposit	36 monthly payments of <sup>1</sup>
S 350 d AMG Line L Saloon	●	●	£72,830.00	£16,841.39	£8,734.54	£619.00
S 350 d SE L Saloon	●	●	£68,870.00	£16,841.39	£8,302.05	£589.00
S 500 e AMG Line L Saloon	●	●	£90,165.00	£16,841.39	£10,498.54	£979.00

● Standard equipment

### Mercedes-Benz Service Care

- Mercedes-Benz trained Technicians
- Maintained by Mercedes-Benz Retailers
- Meets requirements of Mercedes-Benz Agility finance agreement

### Mercedes-Benz Motor Insurance

- 24/7 UK accident recovery
- We use Mercedes-Benz GenuineParts
- To qualify for up to 10% discount online, go to [www.mercedes-benz.co.uk/motorinsurance](http://www.mercedes-benz.co.uk/motorinsurance)
- Alternatively, call Mercedes-Benz Motor Insurance now on **0345 600 2180<sup>4</sup>** for an annual quote

We may decline to quote in some circumstances. Mercedes-Benz Motor Insurance is underwritten by Aviva Insurance Limited

Content relating to finance is promoted by Mercedes-Benz Finance. Your Retailer may offer finance on behalf of other companies.

Orders/credit approvals on selected S-Class Saloon models only, between 1 October and 31 December 2016, registered by 31 March 2017; excluding Mercedes-AMG models. Some combinations of features/options may not be available.

Please contact your local Mercedes-Benz Retailer for availability

<sup>1</sup>Based on a Mercedes-Benz Agility agreement. Vehicle condition, excess mileage and other charges may be payable. Quotations available on request for alternative contract lengths and mileages. Guarantees may be required.

Credit provided subject to status by Mercedes-Benz Finance, MK15 8BA

<sup>2</sup>Payable if you exercise the option to purchase the car

<sup>3</sup>Includes optional purchase payment, purchase activation fee and Retailer deposit contribution (where applicable) <sup>4</sup>Calls are charged at local rate and may be recorded



# Mercedes-Benz Finance

Even the finance offer is beautifully put together

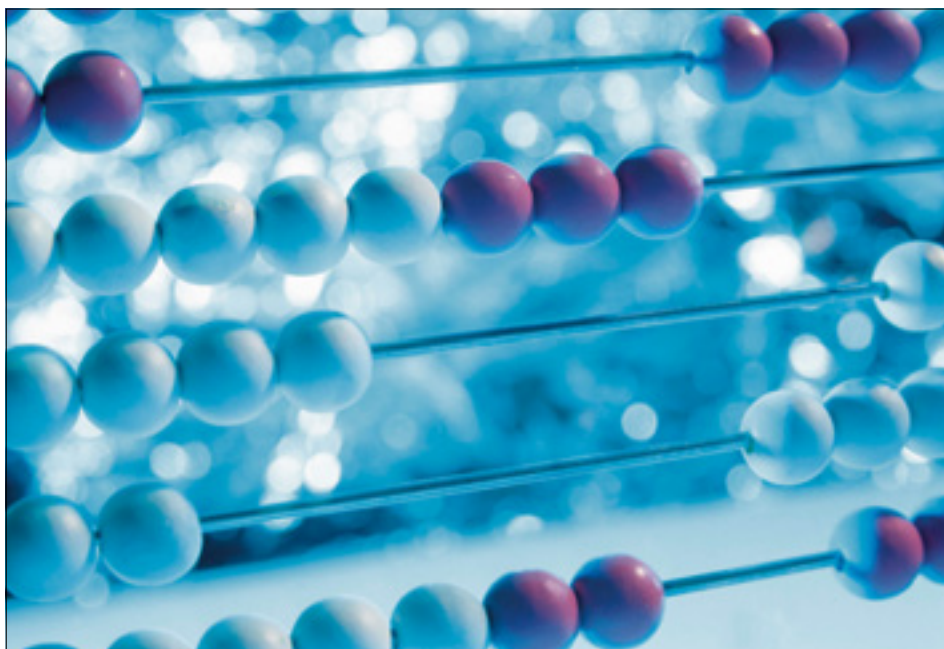

## Mercedes-AMG S 63 L Saloon (representative example)

36 monthly payments of <sup>1</sup>	£1,606.08
Customer deposit	£12,404.62
On-the-road price	£122,595.00
Retailer deposit contribution	£12,035.15
Optional purchase payment <sup>2</sup>	£50,950.00
Amount of credit	£98,155.23
Duration of agreement	36 months
Total amount payable <sup>3</sup>	£133,218.65
Purchase activation fee <sup>2</sup>	£10.00
APR	4.8%
Fixed interest rate	4.67%
Excess mileage	16p per mile



### Example offer – 4.8% APR Representative

	Automatic	Metallic	On-the-road price	Retailer deposit contribution	Customer deposit	36 monthly payments of <sup>1</sup>
Mercedes-AMG S 65 L Saloon	●	●	£183,560.00	£12,035.15	£14,823.27	£2,871.08

● Standard equipment

### Mercedes-Benz Service Care

- Mercedes-Benz trained Technicians
- Maintained by Mercedes-Benz Retailers
- Meets requirements of Mercedes-Benz Agility finance agreement

### Mercedes-Benz Motor Insurance

- 24/7 UK accident recovery
- We use Mercedes-Benz GenuineParts
- To qualify for up to 10% discount online, go to [www.mercedes-benz.co.uk/motorinsurance](http://www.mercedes-benz.co.uk/motorinsurance)
- Alternatively, call Mercedes-Benz Motor Insurance now on **0345 600 2180<sup>4</sup>** for an annual quote

We may decline to quote in some circumstances. Mercedes-Benz Motor Insurance is underwritten by Aviva Insurance Limited

Content relating to finance is promoted by Mercedes-Benz Finance. Your Retailer may offer finance on behalf of other companies.

Orders/credit approvals on Mercedes-AMG S-Class Saloon models only, between 1 October and 31 December 2016, registered by 31 March 2017; excluding non-Mercedes-AMG models. Some combinations of features/options may not be available.

Please contact your local Mercedes-Benz Retailer for availability

<sup>1</sup>Based on a Mercedes-Benz Agility agreement. Vehicle condition, excess mileage and other charges may be payable. Quotations available on request for alternative contract lengths and mileages. Guarantees may be required.

Credit provided subject to status by Mercedes-Benz Finance, MK15 8BA

<sup>2</sup>Payable if you exercise the option to purchase the car

<sup>3</sup>Includes optional purchase payment, purchase activation fee and Retailer deposit contribution (where applicable) <sup>4</sup>Calls are charged at local rate and may be recorded



> View offers



Book a > test drive > AMG test drive



> Find a Retailer



> View the Range Guide

# S-Class SE



Optional 19" alloy wheels - 5-twin-spoke design (code R17)







The S-Class SE offers the most comprehensive equipment for your convenience and all-round protection. AIRMATIC air suspension with Adaptive Damping System is standard, along with a 7G-TRONIC PLUS 7-speed automatic transmission with steering wheel gearshift paddles. On the exterior, you'll also notice the LED Intelligent Light System, which adapts to the conditions around you, as well as 18" alloy wheels in a 5-twin-spoke design.

The welcoming interior is fitted with a steering wheel in nappa leather, dark brown eucalyptus wood trim and exquisite leather upholstery. The innovative combination of COMAND Online and instrument cluster with high-definition TFT display brings new clarity into the cockpit. As you'd expect, the cabin is an oasis of relaxation – with luxury automatic climate control and Frontbass speakers for the perfect sound.

#### Exterior

---

18" alloy wheels – 5-twin-spoke design with 245/50 tyres

---

Active Parking Assist including PARKTRONIC and reversing camera

---

AIRMATIC air suspension with level adjustment and Adaptive Damping System

---

ECO start/stop function

---

Exterior mirrors – electrically adjustable, folding and heated

---

Headlamps – LED Intelligent Light System

#### Interior

---

2-spoke multi-function steering wheel

---

Ambient lighting – choice of seven colour settings

---

Front seats – full electric adjustment and four-way lumbar support

---

Leather upholstery

---

THERMOTRONIC – luxury automatic climate control, two-zone

---

Widescreen cockpit consisting of an Instrument Display and Media Display

#### Trim and Upholstery

---

Dark brown eucalyptus wood



Leather – black



Leather – silk beige/espresso brown



Leather – crystal grey/seashell grey



Leather – nut brown/black





> View offers



Book a > test drive > AMG test drive



> Find a Retailer



> View the Range Guide

## S-Class AMG Line





The S-Class AMG Line enhances the sporty appeal of this stunning saloon. It comes with dynamic AMG bodystyling, comprising front apron, rear apron and side skirts, as well as 19" AMG alloy wheels in 5-twin-spoke design with perforated brake discs, and 'Mercedes-Benz' lettering on the brake calipers. Equally prominent are the visible twin tailpipes on the S 500 L and S 600 L,

which are integrated into the bumper. The interior continues with athletic flair, featuring black poplar wood trim and a 3-spoke multi-function steering wheel, as well as brushed stainless steel sports pedals and velour floor mats with 'AMG' lettering.

#### Exterior

19" AMG alloy wheels – 5-twin-spoke design with 245/45 front and 275/40 rear tyres

Active Parking Assist including PARKTRONIC and reversing camera (360° camera for S 600 L)

AMG bodystyling – front apron, rear apron and side skirts

Headlamps – LED Intelligent Light System

#### Interior

Ambient lighting – choice of seven colour settings

AMG brushed stainless steel sports pedals with rubber studs

Front Seat Memory package (S 500 L and S 600 L only)

Leather upholstery (Exclusive nappa leather upholstery for S 600 L)

Velour floor mats with 'AMG' lettering

Widescreen cockpit consisting of an Instrument Display and Media Display

#### Trim and Upholstery – all models except S 600 L

Black poplar wood



Leather – black



Leather – silk beige/espresso brown



Leather – crystal grey/seashell grey



Leather – nut brown/black



#### S 600 L only

Black poplar wood<sup>1</sup>

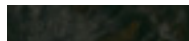

Brown burr walnut wood<sup>1</sup>



Exclusive nappa leather – black



Exclusive nappa leather – silk beige/espresso brown



Exclusive nappa leather – crystal grey/seashell grey



Exclusive nappa leather – nut brown/black



Exclusive nappa leather – porcelain/black

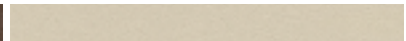

<sup>1</sup>Choice of either black poplar or brown burr walnut wood trim



> View offers



Book a > test drive > AMG test drive



> Find a Retailer



> View the Range Guide

# Premium and Premium Plus equipment lines for S 350 d, S 350 d L, S 300 h



360° camera

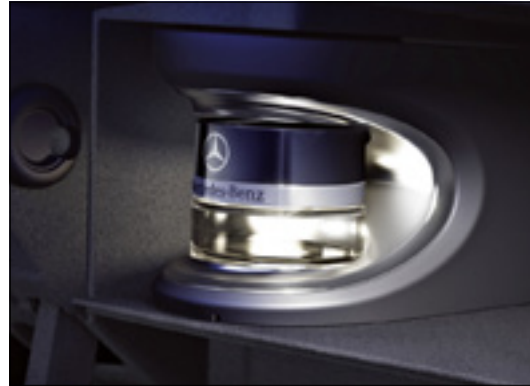

AIR-BALANCE package - for ionisation, air filtration and scenting



Comfort-ventilated front seats



Electric panoramic glass sunroof



Front Seat Comfort package



Nappa leather upholstery





Item	Notes	SE Premium £3,895.00 <sup>1</sup> (code DP0)	AMG Line Premium £4,395.00 <sup>1</sup> (code DP0)	SE Premium Plus £6,695.00 <sup>1</sup> (code DP1)	AMG Line Premium Plus £7,195.00 <sup>1</sup> (code DP1)
Electric panoramic glass sunroof		■	■	■	■
Front Seat Memory package	Additional four-way electric lumbar support for front passenger seat; front seats, luxury front head restraints, steering column and exterior door mirrors – electrically adjustable with memory	■	■	■	■
KEYLESS-GO Comfort package	The vehicle can be conveniently unlocked, started and locked with this access and drive authorisation system – simply by carrying the electronic key. The engine can be switched on and off by pressing the start/stop button in the ignition lock. The hands-free access allows hands-off, fully automatic opening and closing of the boot lid by performing a kicking movement under the rear bumper. The package includes handle recess illumination so that the door handles are easily visible in dark lighting conditions	■	■	■	■
Upholstery – nappa leather		■	■	■	■
20" AMG alloy wheels (4) – multi-spoke design		–	■	–	■
360° camera		–	–	■	■
AIR-BALANCE package – adjustable fragrancing with four different scents	Fragrance generator with perfume flask in glove compartment; improved filter system between intake and distribution system; oxygen ioniser in side air duct	–	–	■	■
Burmester® surround sound system	13 speakers and 9-channel DSP amplifier with total output of 590 W. Includes voice amplification system which makes it easier to communicate with the rear passengers from the front. Two microphones in the interior mirror are also used to pick up speech for the hands-free telephone system. These signals are then discreetly amplified depending on the amount of driving noise, and continuously adjusted for the speaker's volume and the ambient noise level. Not in conjunction with Burmester® high-end 3D surround system (code 811)	–	–	■	■
Comfort-ventilated front seats	Includes seat heating and cooling	–	–	■	■
Front Seat Comfort package	Active multi-contour front seats with dynamic and massage function	–	–	■	■



> View offers



Book a > test drive > AMG test drive



> Find a Retailer



> View the Range Guide

# Mercedes-AMG S 63





> View offers



Book a > test drive > AMG test drive



> Find a Retailer



> View the Range Guide

The Mercedes-AMG S 63 is powered by a mighty V8 biturbo engine delivering 585 hp (430 kW) and a maximum 900 Nm torque. All this energy is channelled by the AMG SPEEDSHIFT MCT 7-speed sports transmission with Controlled Efficiency drive mode and ECO start/stop function. The exterior features AMG front and rear aprons with silver chrome trim, as well as black inserts on the front apron for optimised airflow. AMG forged wheels,

high-performance braking system and AMG logo plus AMG sports exhausts with chromed twin tailpipes complete this powerful ensemble. The style of the Mercedes-AMG S 63 is equally reflected in the interior, with AMG sports seats (with added side bolsters) in nappa leather and contrast stitching, AMG sports steering wheel as well as AMG door sills and sport pedals.

**Exterior**

19" AMG alloy wheels – 10-spoke design with 255/45 front and 285/40 rear tyres

Active Parking Assist including PARKTRONIC and reversing camera

Exterior mirrors – electrically adjustable, folding and heated

Headlamps – LED Intelligent Light System

**Interior**

Ambient lighting – choice of seven colour settings

AMG door sill panels in brushed stainless steel at front and rear, with 'AMG' lettering

AMG sports seats with AMG V8-specific seat layout, optimised lateral support and AMG badge in front and rear backrests

AMG sports steering wheel in 3-spoke design in nappa leather with perforated grip area, 12 buttons, decorative topstitching and silver-coloured aluminium gearshift paddles

AMG widescreen cockpit consisting of an Instrument Display and Media Display including AMG main menu and AMG start-up screen

THERMOTRONIC – luxury automatic climate control, two-zone  
Three different climate modes: Focused, Medium and Diffuse

**Trim and Upholstery**

Black poplar wood

Nappa leather – black



Nappa leather – silk beige/espresso brown

Nappa leather – crystal grey/seashell grey



Nappa leather – nut brown/black

Nappa leather – porcelain/black

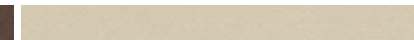



> View offers



Book a > test drive > AMG test drive



> Find a Retailer



> View the Range Guide

# Mercedes-AMG S 65



Optional AMG high-performance ceramic composite brake system shown (code B07)



The AMG styling features a unique front apron, rear apron and side sill panels with high-gloss chrome flics and inserts. Inside, the theme continues with equally exclusive leather and finest trim details. The AMG sport seats with AMG-specific diamond design offer optimum lateral support. The AMG sports steering wheel and airbag cover are fitted with nappa leather, featuring silver-coloured aluminium gearshift paddles.

The driving force behind the S 65 AMG L is an AMG V12 biturbo engine that combines immense power with outstanding refinement. Its 630 hp (463 kW) produces an astonishing maximum torque of 1,000 Nm.

In fact, there is probably only one thing more powerful than the AMG V12: your desire to drive it.

#### Exterior

20" AMG alloy wheels – multi-spoke design with 255/45 front and 285/35 rear tyres

Active Parking Assist including PARKTRONIC and reversing camera

Exterior mirrors – electrically adjustable, folding and heated

Headlamps – LED Intelligent Light System

AMG widescreen cockpit consisting of an Instrument Display and Media Display including AMG main menu and AMG start-up screen

Executive equipment line

Rear Seat Reclining package

#### Interior

AIR-BALANCE package – adjustable fragrancing with four different scents

AMG door sill panels in brushed stainless steel at front and rear, with 'AMG' lettering

AMG sports seats with AMG V12-specific seat layout, optimised lateral support and AMG badge in front and rear backrests

AMG sports steering wheel in 3-spoke design in nappa leather with perforated grip area, 12 buttons, decorative topstitching and silver-coloured aluminium gearshift paddles

#### Trim and Upholstery

Black poplar wood<sup>1</sup>

Brown burr walnut wood<sup>1</sup>

Exclusive nappa leather – black

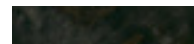

Exclusive nappa leather – silk beige/espresso brown

Exclusive nappa leather – crystal grey/seashell grey



Exclusive nappa leather – nut brown/black

Exclusive nappa leather – porcelain/black

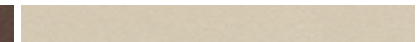

<sup>1</sup>Choice of either black poplar or brown burr walnut wood trim





> View offers



Book a > test drive > AMG test drive



> Find a Retailer



> View the Range Guide

# Executive equipment line



Executive equipment line shown with optional nappa leather



Rear head restraint with comfort cushion



THERMOTRONIC – luxury automatic climate control for the rear

Images shown provide a general indication of interior furnishings. The manufacturer reserves the right to make changes to the design form and specification. Some of the models, features, optional extras and colours shown may not be available in your country or may only be available in a different specification. For more current and specific information in relation to the range of models and features, please contact your nearest authorised Mercedes-Benz Retailer



Given that the S-Class is a thing of beauty in its own right, you might think that there isn't much room for improvement.

With the Executive equipment line, rear passengers can enjoy long journeys in total relaxation. At the touch of a button seats move into a comfortable reclining position, and electrically operated blinds for the rear and side windows shield the occupants from direct sunlight. And with THERMOTRONIC luxury automatic climate control for the rear they enjoy even greater comfort, since temperature and air distribution can be individually adjusted for the left and right sides.

Luxury rear head restraints with an additional comfort cushion ensure the best possible seating comfort for the rear seats.

**Executive equipment line** – including luxury items as listed below.

**Standard on S 600 L and Mercedes-AMG S 65**

<b>S 500 L and Mercedes-AMG S 63</b>	<b>Total incl. VAT £3,510.00</b>
<b>Short wheelbase</b>	<b>£4,335.00</b>
<b>Long wheelbase</b>	<b>£4,000.00</b>

**Executive equipment line** (code DA1)

---

Backrest angle adjustable up to 37°

---

Closing aid for doors and boot lid (code 883)

---

Comfort-ventilated rear seats with cooling and heating function

---

Electrically operated rear seats with memory function

---

Luxury rear head restraints with additional comfort cushion

---

Roller Blind package with electrically operated blinds for rear and side window (code P09)

---

THERMOTRONIC – luxury automatic climate control, rear (code 582)

---



> View offers



Book a > test drive > AMG test drive



> Find a Retailer



> View the Range Guide

## Exclusive driver training for Mercedes-AMG S 63 and S 65 owners

All Mercedes-AMG S 63 and S 65 customers are invited to a complimentary AMG Driving Academy Training experience at Mercedes-Benz World.



With friendly one-to-one tuition from a professional Mercedes-AMG driver, your training will be personalised to you. You'll push Mercedes-AMG driving performance and your driving skills to the limits on our track and purpose-built low friction dynamic handling facilities.

Through high-speed and adrenaline-fuelled exercises you'll experience oversteer, understeer, slaloms and many more performance driving skills. Designed as part of your ownership experience, this will lay the foundations to master a high-performance vehicle, develop driving skills with maximum enjoyment and prepare you to take full command of your own Mercedes-AMG.

### TERMS AND CONDITIONS

The following only are eligible: the first purchaser/registered keeper of a newly-registered Mercedes-AMG S 63 and S 65; the second owner/registered keeper of a Mercedes-AMG purchased from a Mercedes-Benz Retailer, where the vehicle is less than 90 days from registration. The AMG Driving Academy Training experience is the AMG BASIC-Training as detailed in the further information above and must be booked and taken within six months of delivery of your Mercedes-AMG S 63 and S 65; it cannot be exchanged and cannot be transferred for any other driving experience. The Training experience is available Monday to Friday only and is subject to availability. Mercedes-Benz UK Limited reserves the right to amend or withdraw this Training experience. Attendees must hold a full UK driving licence. Attendees will be required to sign the Mercedes-Benz World Driving Risk Acknowledgement prior to undertaking the Training experience. The Training experience is also subject to the Mercedes-Benz World Terms and Conditions, as applicable.



> View offers



Book a > test drive > AMG test drive



> Find a Retailer



> View the Range Guide





## Pricing summary for Executive, Premium and Premium Plus equipment lines

Model	Recommended OTR price (£) <sup>1</sup>											
	SE	SE Executive	SE Executive Premium	SE Executive Premium Plus	SE Premium	SE Premium Plus	AMG Line	AMG Line Executive	AMG Line Executive Premium <sup>2</sup>	AMG Line Executive Premium Plus <sup>2</sup>	AMG Line Premium <sup>2</sup>	AMG Line Premium Plus <sup>2</sup>
<b>S 300 h L</b>	-	-	-	-	-	-	75,000.00	79,000.00	83,395.00	86,195.00	79,395.00	82,195.00
<b>S 350 d</b>	-	-	-	-	-	-	70,780.00	75,115.00	79,550.00	82,350.00	75,215.00	78,015.00
<b>S 350 d L</b>	69,620.00	73,620.00	77,515.00	80,315.00	73,515.00	76,315.00	73,580.00	77,580.00	82,015.00	84,815.00	78,015.00	80,815.00
<b>S 500 e L</b>	-	-	-	-	-	-	90,915.00	94,425.00	-	-	-	-
<b>S 500 L</b>	-	-	-	-	-	-	91,275.00	94,785.00	-	-	-	-

<sup>1</sup>Recommended on-the-road price: these prices reflect the Road Fund Licence applicable to the standard model plus £670.00 additional costs necessary to put your car on the road. Included are a standard UK delivery charge (£540.00 incl. VAT), new vehicle registration fee (£55.00), number plates (£25.00 incl. VAT) and fuel (£50.00 incl. VAT). VAT is calculated at the standard rate of 20%

<sup>2</sup>AMG Line Premium and Premium Plus equipment lines include a larger wheel with greater CO<sub>2</sub> emissions and therefore a different rate of Vehicle Excise Duty (Road Fund Licence)





> View offers



Book a > test drive > AMG test drive



> Find a Retailer



> View the Range Guide

# Standard equipment – SE and AMG Line



Headlamps – LED Intelligent Light System



Active Parking Assist including PARKTRONIC



MAGIC VISION CONTROL



Electrically adjustable front seats



CD/DVD drive (part of COMAND Online system with Media Interface)



Traffic Sign Assist



> View offers



Book a > test drive > AMG test drive



> Find a Retailer



> View the Range Guide

# Standard equipment – S 500 e AMG Line L



Driving and operating mode selection



Plug-in charging port in rear bumper



Mode 2 and mode 3 charging cables included



Energy management modes

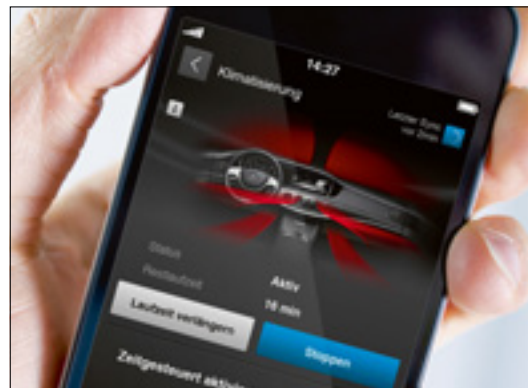

Pre-entry climate control, part of Mercedes connect me services<sup>1</sup>



Anticipatory energy management capabilities

<sup>1</sup>Please contact your Retailer for availability of these services



> View offers



Book a > test drive > AMG test drive



> Find a Retailer



> View the Range Guide

# Standard equipment – S 600 AMG Line L



Multi-function sports steering wheel in wood/leather finish



Rear seats – comfort-ventilated



LED tail lamps



Velour floor mats with 'AMG' lettering



Front Seat Memory package



Brake calipers with 'Mercedes-Benz' lettering



Item	SE L	AMG Line	S 500 e AMG Line L	S 600 AMG Line L	Mercedes-AMG S 63	Mercedes-AMG S 65
<b>Transmission and Suspension</b>						
7G-TRONIC PLUS 7-speed automatic transmission with steering column gear selector, steering wheel gearshift paddles (DIRECT SELECT) and SPEEDTRONIC cruise control	●	●	●	●	-	-
AIRMATIC air suspension with level adjustment and Adaptive Damping System	●	●	●	-	-	-
AMG SPEEDSHIFT PLUS 7G-TRONIC automatic transmission with ECO start/stop function and three transmission modes: 'C' (Controlled Efficiency), 'S' (Sport) and 'M' (Manual)	-	-	-	-	-	●
AMG SPEEDSHIFT MCT 7-speed sports transmission with ECO start/stop function and three transmission modes: 'C' (Controlled Efficiency), 'S' (Sport) and 'M' (Manual)	-	-	-	-	●	-
AMG sports suspension based on MAGIC BODY CONTROL Combines outstanding driving dynamics and precision with a high level of comfort	-	-	-	-	●	●
ECO start/stop function	●	●	●	●	-	-
MAGIC BODY CONTROL	-	-	-	●	-	-

Item	SE L	AMG Line	S 500 e AMG Line L	S 600 AMG Line L	Mercedes-AMG S 63	Mercedes-AMG S 65
<b>Steering</b>						
AMG speed-sensitive sports steering with variable steering ratio	-	-	-	-	●	●
Direct Steering	●	●	●	●	-	-
Steering column – electrically adjustable with EASY-ENTRY function	●	●	●	●	-	-
Steering wheel – 2-spoke multi-function steering wheel	●	-	-	-	-	-
Steering wheel – 3-spoke multi-function sports steering wheel	-	●	●	-	-	-
Steering wheel – 3-spoke multi-function sports steering wheel in wood/leather finish, heated	-	-	-	●	-	-
Steering wheel – AMG sports steering wheel in 3-spoke design in nappa leather with perforated grip area, 12 buttons, decorative topstitching and silver-coloured aluminium gearshift paddles	-	-	-	-	●	●



Item	SE L	AMG Line	S 500 e AMG Line L	S 600 AMG Line L	Mercedes-AMG S 63	Mercedes-AMG S 65
<b>Exterior</b>						
KEYLESS-GO Comfort package The vehicle can be conveniently unlocked, started and locked with this access and drive authorisation system – simply by carrying the electronic key. The engine can be switched on and off by pressing the start/stop button in the ignition lock. The hands-free access allows hands-off, fully automatic opening and closing of the boot lid by performing a kicking movement under the rear bumper. The package includes handle recess illumination so that the door handles are easily visible in dark lighting conditions	○	○	○	●	●	●
Active Parking Assist including PARKTRONIC and reversing camera	●	●	●	-	●	-
Active Parking Assist including PARKTRONIC and 360° camera	○	○	○	●	-	●
AMG bodystyling – front apron, rear apron and side skirts	-	●	●	●	-	-
AMG bodystyling Comprising S 63-specific front apron featuring cross strut in silver chrome and inserts in high-gloss black, with silver chrome inserts for rear apron and side sill panels	-	-	-	-	●	-
AMG bodystyling Comprising S 65-specific front apron featuring cross strut and flics in high-gloss chrome with high-gloss chrome inserts for rear apron and side sill panels	-	-	-	-	-	●
AMG high-performance composite brake system with 390×36 mm composite brakes at front and 360×26 mm brake discs at rear	-	-	-	-	●	●

Item	SE L	AMG Line	S 500 e AMG Line L	S 600 AMG Line L	Mercedes-AMG S 63	Mercedes-AMG S 65
<b>Exterior (continued)</b>						
AMG sports exhaust system with two chrome-plated twin exhaust trims	-	-	-	-	●	●
Charging cable for household socket (mode 2) – 4 m, 8 A	-	-	●	-	-	-
Charging cable for wallbox and public charging stations (mode 3) – 4 m, 16 A	-	-	●	-	-	-
Closing aid for doors and boot lid S 500 L and S 600 L only	-	●	●	●	●	●
Diesel Particulate Filter (DPF) S 300 h L and S 350 d (L)	●	●	-	-	-	-
Doorhold system	●	●	●	●	●	●
Exterior mirrors – electrically adjustable, folding and heated	●	●	●	●	●	●
Electric panoramic glass sunroof	○	○	○	●	●	●
Exhaust system – without visible tailpipes S 350 d (L)	●	-	-	-	-	-
Exhaust system – without twin visible tailpipes, with chrome trim S 300 h L, S 350 d and S 350 d (L)	-	●	-	-	-	-
Exhaust system – with twin visible tailpipes integrated into bumper S 500 L and S 600 L	-	●	●	●	-	-
Headlamps – LED Intelligent Light System LED headlamps with variable light distribution for country roads and motorways, Active Light System, cornering light function, extended fog light function and Adaptive Highbeam Assist	●	●	●	●	●	●





Item	SE L	AMG Line	S 500 e AMG Line L	S 600 AMG Line L	Mercedes-AMG S 63	Mercedes-AMG S 65
Infrared-reflective, noise insulating glass all round Standard for S 500 AMG Line L only	○	○	●	●	●	●
LED tail lamps	●	●	●	●	●	●
MAGIC VISION CONTROL – adaptive windscreen wiper system, heated	●	●	●	●	●	●
Remote boot lid release	●	●	●	●	●	●
Tinted glass – green	●	●	●	●	●	●
TIREFIT tyre-sealant kit	●	●	●	●	●	●
‘V8 BITURBO’ lettering on front wings	–	–	–	–	●	–
‘V12 BITURBO’ lettering on front wings	–	–	–	–	–	●
‘V12’ lettering on front wings	–	–	–	●	–	–
Visual differentiation for PLUG-IN HYBRID Badge with ‘PLUG-IN HYBRID’ lettering on wings (not deselectable) Blue front brake calipers (deselectable with code U53) Blue accentuating rings in headlamps (deselectable with code U53)	–	–	●	–	–	–

Item	SE L	AMG Line	S 500 e AMG Line L	S 600 AMG Line L	Mercedes-AMG S 63	Mercedes-AMG S 65
<b>Interior</b>						
AIR-BALANCE package – adjustable fragrancing with four different scents	○	○	○	●	○	●
Executive equipment line Backrest angle adjustable up to 37° Closing aid for doors and boot lid (code 883) Comfort-ventilated rear seats with cooling and heating function Electrically operated rear seats with memory function THERMOTRONIC – luxury automatic climate control, rear (code 582) Luxury rear head restraints with additional comfort cushion Roller Blind package (code P09)	○	○	○	●	○	●
Front Seat Comfort package Active multi-contour seats with dynamic and massage function	○	○	○	●	●	●
Front Seat Memory package Additional four-way electric lumbar support for front passenger seat Front seats, front head restraints, steering column and exterior door mirrors – electrically adjustable with memory Standard on S 500 L	○	○	●	●	●	●
Rear Seat Comfort package Active multi-contour rear seats with dynamic and massage function Burmester® surround sound system (code 810) Rear seat entertainment system (code P46)	○	○	○	●	–	–



Item	SE L	AMG Line	S 500 e AMG Line L	S 600 AMG Line L	Mercedes-AMG S 63	Mercedes-AMG S 65
<b>Interior (continued)</b>						
Rear Seat Reclining package EASY ADJUST luxury front head restraints (code 439) Front passenger seat with extended adjustment Reclining rear seat (up to 43.5°) behind front passenger, and additional leg rest and footrest	○	○	○	●	○	●
Warmth Comfort package Armrest heating in front and rear Heated multi-function steering wheel	○	○	○	●	○	●
12 V socket – on centre console, front and rear, and in boot	●	●	●	●	–	–
Ambient lighting – choice of seven colour settings	●	●	●	●	●	●
AMG brushed stainless steel sports pedals with rubber studs	–	●	●	●	–	–
AMG door sill panels in brushed stainless steel at front and rear, with 'AMG' lettering	–	–	–	–	●	●
AMG emblem embossed in front centre armrest. Front and rear centre armrest with stowage	–	–	–	–	●	●
AMG sports pedals in brushed stainless steel with rubber studs	–	–	–	–	●	●

Item	SE L	AMG Line	S 500 e AMG Line L	S 600 AMG Line L	Mercedes-AMG S 63	Mercedes-AMG S 65
AMG-specific IWC-design analogue clock	–	–	–	–	●	●
AMG sports seats with AMG V8-specific seat layout, optimised lateral support and AMG badge in front and rear backrests	–	–	–	–	●	–
AMG sports seats with AMG V12-specific seat layout, optimised lateral support and AMG badge in front and rear backrests	–	–	–	–	–	●
AMG widescreen cockpit consisting of an Instrument Display and Media Display including AMG main menu and AMG start-up screen	–	–	–	–	●	●
Analogue clock with Mercedes-Benz star	●	●	●	●	–	–
Automatically dimming rear-view mirror and driver's exterior mirror	●	●	●	●	●	●
Brake calipers with 'AMG' lettering	–	–	–	–	●	●
Brake calipers with 'Mercedes-Benz' lettering	–	●	●	●	–	–
Centre armrests – front and rear, with stowage	●	●	●	●	–	–
Cup holders – front (2) and rear (2)	●	●	●	●	–	–
Door sill panels with stainless steel inlays – front with 'Mercedes-Benz' lettering	●	●	●	–	–	–



Item	SE L	AMG Line	S 500 e AMG Line L	S 600 AMG Line L	Mercedes-AMG S 63	Mercedes-AMG S 65
<b>Interior (continued)</b>						
Electric windows (4) with PRE-SAFE® closing function	●	●	●	●	●	●
Floor mats – AMG Exclusive floor mats with 'AMG' lettering	-	-	-	-	●	●
Floor mats – velour floor mats	●	-	-	-	-	-
Floor mats – velour floor mats with 'AMG' lettering	-	●	●	●	-	-
Front seats – comfort-ventilated	○	○	○	○	○	●
Front seats – full electric adjustment Fore and aft, height, inclination and seat cushion length adjustment, electric head restraint height adjustment and four-way electric lumbar support	●	●	●	●	-	-
Front seats – heated	●	●	●	-	●	-
Garage door opener – integrated in rear-view mirror For questions regarding compatibility please visit <a href="http://www.homelink.com">www.homelink.com</a>	○	○	○	●	○	●
Glasses stowage compartment	●	●	●	●	●	●
Glove compartment – lockable, air-conditioned and illuminated	●	●	●	●	●	●
Head restraints, rear (3) – electrically lowering	●	●	●	●	●	●

Item	SE L	AMG Line	S 500 e AMG Line L	S 600 AMG Line L	Mercedes-AMG S 63	Mercedes-AMG S 65
Illuminated door sill panels	●	●	●	●	●	●
Illuminated vanity mirrors – front and rear	●	●	●	●	●	●
KEYLESS-GO starting function	●	●	●	●	●	●
Load securing rings in boot	●	●	●	●	-	-
Map pockets on front seat backrests	●	●	●	●	-	-
Outside temperature gauge	●	●	●	●	●	●
Parcel nets in boot and front passenger footwell	●	●	●	●	●	●
Reading lights – front and rear	●	●	●	●	●	●
Rear seats – comfort-ventilated	-	-	-	●	○	●
Rear seats – heated	●	●	●	-	●	-
Rear sill protector – black S 300 h L and S 350 d (L)	●	●	●	-	-	-



Item	SE L	AMG Line	S 500 e AMG Line L	S 600 AMG Line L	Mercedes-AMG S 63	Mercedes-AMG S 65
<b>Interior (continued)</b>						
Rear sill protector – chrome S 500 L and S 600 L only	-	●	●	●	-	-
Stowage compartment in rear seat armrest	●	●	●	●	●	●
THERMOTRONIC – luxury automatic climate control, rear	○	○	○	○	○	●
THERMOTRONIC – luxury automatic climate control, two-zone Three climate modes: Focused, Medium and Diffuse	●	●	●	●	●	●
Trip computer – in multi-function display, showing current fuel consumption	●	●	●	●	●	●
Widescreen cockpit consisting of an Instrument Display and Media Display	●	●	●	●	-	-
<b>Paint, Trim and Upholstery</b>						
Dashboard – upper section in ARTICO leather <sup>1</sup>	●	●	●	-	-	-
Dashboard – upper section in nappa leather	-	-	-	●	-	-
Paint – metallic	●	●	●	●	●	●
Trim – dark brown eucalyptus wood	●	-	-	-	-	-
Trim – black poplar wood	○	●	●	○	●	○

Item	SE L	AMG Line	S 500 e AMG Line L	S 600 AMG Line L	Mercedes-AMG S 63	Mercedes-AMG S 65
<b>Upholstery – Exclusive Nappa Leather package</b>						
Armrests and lining of centre console in nappa leather with contrast stitching	○	○	○	●	○	●
Colour contrast fluting on beltline						
DINAMICA microfibre roof lining						
Door panels with hand-stitched facings in nappa leather						
Exclusive nappa leather upholstery						
Extended trim parts: additional wood trim in door centre panels and rear air vent covers						
Nappa leather upper dashboard with diamond-pattern perforations and contrast stitching						
Perforated diamond pattern in continuation of front door armrests and in rear door seat function control panels						
Seats in diamond pattern nappa leather with contrast stitching						
Trim – choice of black poplar or brown burr walnut wood trim (no-cost option)						
Upholstery – leather	●	●	●	-	-	-
Upholstery – nappa leather	-	-	-	-	●	-





Item	SE L	AMG Line	S 500 e AMG Line L	S 600 AMG Line L	Mercedes-AMG S 63	Mercedes-AMG S 65
<b>Safety and Assistance Systems</b>						
Driving Assistance package Active Blind Spot Assist, Active Lane Keeping Assist, BAS PLUS with Cross-Traffic Assist, DISTRONIC PLUS with Steer Assist and Stop&Go Pilot, PRE-SAFE® Brake and PRE-SAFE® PLUS	○	○	○	●	●	●
Intelligent Rear Seat Belts package Illuminated seat belt buckle extenders facilitate seat belt fastening on outer rear seats Inflatable three-point seat belts with integrated belt bags on outer seats	○	○	○	●	○	●
Active bonnet – pedestrian safety measure	●	●	●	●	●	●
Adaptive brake lights	●	●	●	●	●	●
Airbags – driver and front passenger	●	●	●	●	●	●
Airbags – front and rear sidebags	●	●	●	●	●	●
Airbags – windowbags	●	●	●	●	●	●
Alarm system with immobiliser and interior protection (MBSS3)	●	●	●	●	●	●
Anti-lock braking system (ABS) with Brake Assist (BAS)	●	●	●	●	●	●
ATTENTION ASSIST Monitors steering behaviour and can help alert to long journey fatigue	●	●	●	●	●	●

Item	SE L	AMG Line	S 500 e AMG Line L	S 600 AMG Line L	Mercedes-AMG S 63	Mercedes-AMG S 65
Automatic child seat recognition sensor Works in conjunction with Mercedes-Benz child seats fitted with transponder	●	●	●	●	●	●
Brake pad wear indicator – front brakes	●	●	●	●	●	●
COLLISION PREVENTION ASSIST PLUS	●	●	●	-	-	-
Crosswind Assist	●	●	●	●	●	●
Electric parking brake	●	●	●	●	●	●
Electronic Stability Programme (ESP®) with Acceleration Skid Control (ASR)	●	●	●	●	●	●
ESP® Curve Dynamic Assist	●	●	●	●	●	●
First-aid kit	●	●	●	●	●	●
Front passenger seat with PRE-SAFE® positioning function	●	●	●	●	●	●
Headlamp Assist – automatic headlamp activation	●	●	●	●	●	●
i-Size and ISOFIX child seat fixing points in rear (two outer seats)	●	●	●	●	●	●
Locking wheel bolts	●	●	●	●	●	●



Item	SE L	AMG Line	S 500 e AMG Line L	S 600 AMG Line L	Mercedes-AMG S 63	Mercedes-AMG S 65
<b>Safety and Assistance Systems (continued)</b>						
Night View Assist Plus With early detection of people and large animals in the dark, including spotlight function and windscreen with heat and noise-insulating and infrared-reflecting glass	○	○	○	●	○	●
PRE-SAFE® anticipatory occupant protection system	●	●	●	●	●	●
PRE-SAFE® Impulse	●	●	●	●	●	●
Rain-sensing wipers – two-stage	●	●	●	●	●	●
Rear seat belt status indicator	●	●	●	●	●	●
Remote central locking	●	●	●	●	●	●
Seat belts, rear – three-point (3)	●	●	●	●	●	●
Seat belt pre-tensioners, belt force limiters and automatic belt height adjustment – front and outer rear seats	●	●	●	●	●	●
Service indicator ASSYST	●	●	●	●	●	●
Traffic Sign Assist Speed Limit Assist with wrong-way warning function and display of speed limit in instrument cluster	●	●	●	●	●	●
Tyre pressure monitoring system	●	●	●	●	●	●

Item	SE L	AMG Line	S 500 e AMG Line L	S 600 AMG Line L	Mercedes-AMG S 63	Mercedes-AMG S 65
<b>Communications and In-Car Entertainment</b>						
6-disc changer	○	○	○	●	●	●
Burmester® high-end 3D surround sound system 24 speakers and 24-channel amplifier with total output of 1,540 W	○	○	○	●	○	●
Burmester® surround sound system 13 speakers and 9-channel DSP amplifier with total output of 590 W	○	○	○	-	●	-
Central controller dial to operate audio functions and telephone (when connected)	●	●	●	●	●	●
COMAND Online system with Media Interface and touchpad Includes radio, single CD/DVD (6-disc changer for S 600 L), 12.3-inch colour display, hard disk drive (HDD) navigation with 3D map display, Live Traffic Information and European map data updates free of charge for the first three years, Speed Limit Assist and LINGUATRONIC voice control. Integrated WLAN hotspot for onboard access of WLAN-enabled devices. Also includes SD memory card slot, 10 GB music register and MP3 compatibility. Bluetooth® interface with high-definition call quality for hands-free telephony. Media Interface allows connection and control of portable media devices (e.g. MP3 player, USB storage media)	●	●	●	●	●	●







Item	SE L	AMG Line	S 500 e AMG Line L	S 600 AMG Line L	Mercedes-AMG S 63	Mercedes-AMG S 65
<b>Communications and In-Car Entertainment (continued)</b>						
DAB digital radio tuner	●	●	●	●	●	●
Digital operating instructions	●	●	●	●	●	●
Head-up display Virtual colour image (21×7 cm) showing information such as vehicle speed directly in driver's field of vision	○	○	○	●	○	●
Mercedes me connect (additional services) Including programming of pre-entry climate control, route planning, retrieval of vehicle level of charge, programming of charging settings. Please contact your Retailer for availability of these services	-	-	●	-	-	-
Mercedes me connect (standard services) Including emergency call system (eCall), accident recovery, breakdown management and maintenance management; Mercedes-Benz apps and in-car internet access for Facebook, internet radio, sending routes from Google Maps™ to the vehicle, news and weather reports; internet-enabled mobile phone required	●	●	●	●	●	●
Near Field Communication Enables a convenient, wireless connection of the mobile phone with the vehicle's telematics simply by holding the mobile phone near the NFC logo on the head unit	●	●	●	●	●	●

Item	SE L	AMG Line	S 500 e AMG Line L	S 600 AMG Line L	Mercedes-AMG S 63	Mercedes-AMG S 65
Rear seat entertainment system Two 10-inch screens on rear seat backrests, DVD player, two sets of wireless headphones and remote control for COMAND Online system	○	○	○	●	○	●
Rear seat telephony	○	○	○	●	○	●
Speakers with Frontbass	●	●	●	●	●	●
SPLITVIEW for COMAND Online system Allows different content to be displayed for driver and passenger	○	○	○	●	○	●
TV tuner - with digital reception capabilities	○	○	○	●	○	●
Universal Telephony package in armrest with universal interface for universal cradle, extended telephone functionality, charging function and LTE-compatible exterior aerial for optimum reception	○	○	○	●	○	●



# A revolution in style

Item	Notes		SE L	AMG Line	S 500 e AMG Line L	S 600 AMG Line L	Mercedes-AMG S 63	Mercedes-AMG S 65	Basic RRP excl. VAT (£)	Total RRP incl. VAT (£)	
<b>Wheels</b>											
18" alloy wheels (4) – 5-twin-spoke design front: 245/50 tyres rear: 245/50 tyres			01R	●	-	-	-	-	-	-	
19" alloy wheels (4) – 5-twin-spoke design front: 245/45 tyres rear: 275/40 tyres			R17	○	-	-	-	-	1,458.33	1,750.00	
19" AMG alloy wheels (4) – 5-twin-spoke design front: 245/45 tyres rear: 275/40 tyres			793	-	●	●	●	-	-	-	
20" AMG alloy wheels (4) – multi-spoke design front: 245/40 tyres rear: 275/35 tyres			769	-	○	○	○	-	-	650.00	780.00





> View offers







Book a > test drive > AMG test drive



> Find a Retailer



> View the Range Guide

Item	Notes		SEL	AMG Line	S 500 e AMG Line L	S 600 AMG Line L	Mercedes-AMG S 63	Mercedes-AMG S 65	Basic RRP excl. VAT (£)	Total RRP incl. VAT (£)	
<b>Wheels (continued)</b>											
19" AMG alloy wheels (4) – 10-spoke design front: 255/45 tyres rear: 285/40 tyres			788	-	-	-	-	●	-	-	
20" AMG alloy wheels (4) – multi-spoke design front: 255/40 tyres rear: 285/35 tyres			696	-	-	-	-	●	-	-	
20" AMG alloy wheels (4) – 10-spoke design front: 255/40 tyres rear: 285/35 tyres			647	-	-	-	-	○	-	808.33	970.00
				-	-	-	-	-	○	no-cost option	
20" AMG alloy wheels (4) – 10-spoke design, painted matt black front: 255/40 tyres rear: 285/35 tyres			648	-	-	-	-	○	-	1,450.00	1,740.00
				-	-	-	-	-	○	no-cost option	

● Standard ○ Optional - Not available



# Driving Assistance package

For increased traffic safety, the S-Class can be equipped with the Driving Assistance package. DISTRONIC PLUS with Steering Assist and Stop&Go Pilot help the driver to maintain a safe distance to the vehicle in front and stay in lane, while BAS PLUS with Cross-Traffic Assist and PRE-SAFE® Brake helps to reduce the risk of accidents at junctions and in stop-start traffic. Active Lane Keeping Assist and Active Blind Spot Assist support the driver if they should inadvertently drift out of lane or risk collision with another vehicle while changing lanes.

**Driving Assistance package** – including luxury items as listed below.  
**Standard on S 600 L, Mercedes-AMG S 63 and Mercedes-AMG S 65**  
**All other models** **Total incl. VAT £1,695.00**

**Driving Assistance package** (code P20)

Active Blind Spot Assist
Active Lane Keeping Assist
BAS PLUS with Cross-Traffic Assist
DISTRONIC PLUS with Steering Assist and Stop&Go Pilot
PRE-SAFE® Brake and PRE-SAFE® PLUS



DISTRONIC PLUS



Active Lane Keeping Assist



> View offers



Book a > test drive > AMG test drive



> Find a Retailer



> View the Range Guide

## Rear Seat Reclining package and Individual Rear Seats package



Reclining rear seat with additional leg and footrest (part of the Rear Seat Reclining package), as well as individual rear seats with folding rear tables (part of the Individual Rear Seats package) shown

Please note: left-hand drive car shown. For UK vehicles the reclining seat with leg rest and footrest is on the left, behind the passenger seat



Two separate packages, two ways to further enhance your comfort in the S-Class. The Rear Seat Reclining package features beautifully convenient elements like extended adjustment and luxury head restraints for the front seats, as well as reclining rear sets, and additional leg rest and footrest. It's available with either the Executive equipment line or the Individual Rear Seats package.

The Individual Rear Seats package maximises the luxurious atmosphere. It allows you to adjust the backrest angle up to 37°, adds comfort-ventilation and electric adjustment with memory function. The rear seats even come with folding tables and temperature-controlled cupholders. This package is available individually or in conjunction with the Rear Seat Comfort package or the Rear Seat Reclining package.

**Rear Seat Reclining package** – including luxury items as listed below.

**Standard on S 600 L and Mercedes-AMG S 65**

**All other models**

**Total incl. VAT £1,500.00**

**Rear Seat Reclining package** (code DA4)

EASY ADJUST luxury front head restraints (code 439)

Front passenger seat with extended adjustment

Reclining rear seat (up to 43.5°) behind front passenger, and additional leg rest and footrest

**Individual Rear Seats package** – including luxury items as listed below.

**S 600 L and Mercedes-AMG S 65**

**All other models**

**Total incl. VAT £2,900.00**

**VAT £5,000.00**

**Individual Rear Seats package** (code DA2)

Backrest angle adjustable up to 37°

Cup holders (2) – temperature-controlled

Individual rear seats and folding rear tables

Luxury rear head restraints with additional comfort cushion

Rear seats – comfort-ventilated

Rear seats – electrically adjustable with memory function

Stowage compartment with two 12V sockets





> View offers



Book a > test drive > AMG test drive



> Find a Retailer



> View the Range Guide

# Rear Seat Comfort package



The rear seat entertainment system features 10-inch screens



Burmester® surround sound system



Control of the energising massage function is available via COMAND Online



The Rear Seat Comfort package combines sublime comfort with a premium audio experience. It includes active multi-contour rear seats with a dynamic and a massage function. Individually adaptable air chambers in the multi-contour seats can be adjusted to the occupant's physique by using the COMAND Online controls. The dynamic function ensures the best support, especially when cornering: depending on steering angle and speed, the air pressure in the side bolsters is automatically increased for maximum lateral support. The seats even come with a massage function which allows you to choose between six settings, from relaxing to highly energising. For the most inspiring audio experience, there is the Burmester® surround sound system with thirteen high-performance speakers and a rear seat entertainment system. The passengers in the rear can independently access the DVD player connected with COMAND Online, radio, internet or television in conjunction with a TV receiver (optional), or connect external devices using the two USB and aux-in ports in the rear armrest. Two wireless headphones are also included.

The Rear Seat Comfort package is available exclusively with either the Executive equipment line or the Individual Rear Seats package. Also requires the Front Seat Memory package and EASY ADJUST luxury front head restraints.

**Rear Seat Comfort package** – including luxury items as listed below.

**Standard on S 600 L and Mercedes-AMG S 65**

<b>Mercedes-AMG S 63</b>	<b>Total incl. VAT £2,370.00</b>
<b>All other models</b>	<b>£3,500.00</b>
<b>With Premium Plus equipment line (code DP 1)</b>	<b>£2,995.00</b>

**Rear Seat Comfort package** (code DA3)

---

Active multi-contour rear seats with dynamic and massage function

---

Burmester® surround sound system (code 810)

---

Rear seat entertainment system (code P46)

---



> View offers



Book a > test drive > AMG test drive



> Find a Retailer



> View the Range Guide

# Optional equipment



AMG Night package



Burmester® high-end 3D surround sound system



MAGIC SKY CONTROL



Privacy glass



Rear Seat Telephony



Universal Telephony package



Item	Notes		SE L	AMG Line	S 500 e AMG Line L	S 600 AMG Line L	Mercedes-AMG S 63	Mercedes-AMG S 65	Basic RRP excl. VAT (£)	Total RRP incl. VAT (£)
<b>AMG Performance Studio</b>										
AMG Driver's package Including restriction of top speed to 186mph and participation in driver training at the AMG Driving Academy		250	-	-	-	-	○	-	2,300.00	2,760.00
			-	-	-	-	○	658.33	790.00	
AMG Exterior Carbon Fibre Trim package Comprising cross strut on front apron, exterior mirror housings, inserts in rear apron and carbon fibre inserts in side sill panels		773	-	-	-	-	○	○	4,166.67	5,000.00
AMG high-performance ceramic composite brake system With composite brake discs, 420×40 mm front and 360×32 mm rear, as well as specially painted brake calipers with 'AMG Carbon Ceramic' lettering	Only in conjunction with 20" AMG alloy wheels (code 647, 648 or 696). Please check with your Retailer for availability	B07	-	-	-	-	○	○	5,908.33	7,090.00
AMG carbon fibre engine cover		B14	-	-	-	-	○	-	1,291.67	1,550.00
Air inlet grilles and flics on front apron in high-gloss black instead of high-gloss chrome		5U2	-	-	-	-	-	○	<b>no-cost option</b>	
Brake calipers – painted red, with 'AMG' lettering	Not in conjunction with AMG high-performance ceramic composite brake system (code B07)	U70	-	-	-	-	○	○	516.67	620.00



Item	Notes		SE L	AMG Line	S 500 e AMG Line L	S 600 AMG Line L	Mercedes-AMG S 63	Mercedes-AMG S 65	Basic RRP excl. VAT (£)	Total RRP incl. VAT (£)
<b>Suspension and Exterior</b>										
Night package AMG side sill panel inserts in high-gloss black AMG sport exhaust system with two black twin tailpipe trims in chrome finish Cross strut in front apron in high-gloss black Exterior mirror housings in high-gloss black Rear apron insert in high-gloss black	In conjunction with AMG Exterior Carbon Fibre Trim package (code 773)	P60	-	-	-	-	○	○	329.17	<b>395.00</b>
			-	-	-	-	○	○	612.50	<b>735.00</b>
360° camera	Replaces standard reversing camera	501	○	○	○	●	○	●	733.33	<b>880.00</b>
Charging cable for IEC 60309 3-pin industrial socket (mode 2) – 4 m, 8 A		B32	-	-	○	-	-	-	312.50	<b>375.00</b>
Charging cable for household socket (mode 2) – 8 m, 8 A	Replaces standard charging cable for household socket (mode 2) – 4 m, 8 A	B81	-	-	○	-	-	-		<b>no-cost option</b>
Charging cable for IEC 60309 3-pin industrial socket (mode 2) – 8 m, 8 A		B82	-	-	○	-	-	-	312.50	<b>375.00</b>
Charging cable for wallbox and public charging stations (mode 3) – 8 m, 16 A	Replaces standard charging cable for wallbox and public charging stations (mode 3) – 4 m, 16 A	B83	-	-	○	-	-	-		<b>no-cost option</b>
MAGIC BODY CONTROL	S 500 L only. Only in conjunction with Driving Assistance package (code P20)	487	-	○	-	●	-	-	3,616.67	<b>4,340.00</b>
Omit model designation	Deletes model and engine badging. Retains central Mercedes-Benz star on boot lid. Not available for S 300 h L	260	○	○	-	○	-	-		<b>no-cost option</b>
Omit the following visual differentiation for PLUG-IN HYBRID: Blue front brake calipers Blue accentuating rings in headlamps		U53	-	-	○	-	-	-		<b>no-cost option</b>





Item	Notes		SE L	AMG Line	S 500 e AMG Line L	S 600 AMG Line L	Mercedes-AMG S 63	Mercedes-AMG S 65	Basic RRP excl. VAT (£)	Total RRP incl. VAT (£)
<b>Suspension and Exterior (continued)</b>										
Privacy glass – dark glass from B-pillar backwards		840	○	○	○	-	○	-	333.33	400.00
			-	-	-	○	-	○	no-cost option	
Tow bar, manually folding with electric release When ordering this option, please discuss with your Retailer any specific electrical towing requirements	Only available for S350 d (L)	550	○	-	-	-	-	-	975.00	1,170.00
<b>Paint, Trim and Upholstery</b>										
Paint – designo allanite grey magno	Only in conjunction with electric panoramic glass sunroof (code 413). designo magno matt paint finishes require extra care. Please refer to the Owner's Manual for instructions	044	○	○	○	○	○	○	3,041.67	3,650.00
Paint – designo cashmere white magno		049	○	○	○	○	○	○	3,041.67	3,650.00
Paint – designo black mocha metallic	Only in conjunction with electric panoramic glass sunroof (code 413)	033	○	○	○	○	○	○	2,608.33	3,130.00
Paint – designo diamond white bright		799	○	○	○	○	○	○	633.33	760.00
Trim – AMG carbon fibre/black piano lacquer	Only in conjunction with Exclusive Nappa Leather package (code P34)	H10	○	○	○	○	○	○	2,400.00	2,880.00
Trim – black poplar wood		729	○	●	●	-	●	-	358.33	430.00
	In conjunction with Exclusive Nappa Leather package (code P34)		○	○	○	-	○		no-cost option	
Trim – brown burr walnut wood		731	○	-	-	-	-	-	400.00	480.00
			-	○	○	-	○	-	41.67	50.00
	In conjunction with Exclusive Nappa Leather package (code P34)		○	○	○	-	○		no-cost option	
Trim – designo black piano lacquer	Only in conjunction with Exclusive Nappa Leather package (code P34)	H21	○	○	○	○	○	1,025.00	1,230.00	



Item	Notes		SE L	AMG Line	S 500 e AMG Line L	S 600 AMG Line L	Mercedes-AMG S 63	Mercedes-AMG S 65	Basic RRP excl. VAT (£)	Total RRP incl. VAT (£)
<b>Paint, Trim and Upholstery (continued)</b>										
Trim – designo black piano lacquer flowing lines	Only in conjunction with Exclusive Nappa Leather package (code P34)	H16	○	-	-	-	○	○	1,633.33	<b>1,960.00</b>
			-	○	○	-	-	-	1,345.83	<b>1,615.00</b>
			-	-	-	○	-	-	820.82	<b>985.00</b>
Trim – designo brown sunburst myrtle wood	Only in conjunction with Exclusive Nappa Leather package (code P34) in black (code 501/561) or porcelain/black (code 515/585)	7Z7	○	○	○	○	○	○	191.67	<b>230.00</b>
Trim – designo metallised ash wood	Only in conjunction with Exclusive Nappa Leather package (code P34) in black (code 501/561) or porcelain/black (code 515/585)	H06	○	○	○	○	○	○	316.67	<b>380.00</b>
Upholstery – Exclusive Nappa Leather package Armrests and lining of centre console in nappa leather with contrast stitching Colour contrast fluting on beltline DINAMICA microfibre roof lining Door panels with hand-stitched facings in nappa leather Exclusive nappa leather upholstery Extended trim parts: additional wood trim in door centre panels and rear air vent covers Nappa leather upper dashboard with diamond-pattern perforations and contrast stitching Perforated diamond pattern in continuation of front door armrests and in rear door seat function control panels Seats in nappa leather upholstery (featuring diamond pattern) with contrast stitching Trim – choice of black poplar or brown burr walnut wood trim (no-cost option)	Only in conjunction with either Executive equipment line (code DA1) or Individual Rear Seats package (code DA2) and Roller Blind package (code P09). On short wheelbase models, only in conjunction with electric panoramic glass sunroof (code 413) and Executive equipment line (code DA1)	P34	○	-	-	-	-	-	5,741.67	<b>6,890.00</b>
			-	○	○	-	-	-	5,441.67	<b>6,530.00</b>
			-	-	-	●	○	●	3,991.67	<b>4,790.00</b>



Item	Notes		SE L	AMG Line	S 500 e AMG Line L	S 600 AMG Line L	Mercedes-AMG S 63	Mercedes-AMG S 65	Basic RRP excl. VAT (£)	Total RRP incl. VAT (£)
<b>Paint, Trim and Upholstery (continued)</b>										
Upholstery – designo semi-aniline leather Additional to Exclusive Nappa Leather package (code P34) designo floor mats Quilted diamond pattern repeated in centre section of dashboard Seats in designo semi-aniline leather with exclusive diamond design additional to entire seat centre section, upholstery buttons, budapest piping and designo badges  Available in: designo silk beige/titanium grey pearl P62 designo silk beige/satin red pearl P87	Only in conjunction with Exclusive Nappa Leather package (code P34) and Front Seat Memory package (code P64). For short wheelbase models, only in conjunction with electric panoramic glass sunroof (code 413). Not in conjunction with designo metallised ash wood trim (code H06)	'	○	○	○	○	-	-	2,666.67	3,200.00
	Only in conjunction with Exclusive Nappa Leather package (code P34). Not in conjunction with designo metallised ash wood trim (code H06)		-	-	-	-	○	○	658.33	790.00
Upholstery – nappa leather		'	○	○	○	-	○	-	1,450.00	1,740.00
<b>Comfort</b>										
AIR-BALANCE package – adjustable fragrancing with four different scents Fragrance generator with perfume flask in glove compartment Improved filter system between intake and distribution system Oxygen ioniser in side air duct		P21	○	○	○	●	○	●	300.00	360.00
Front Seat Comfort package Active multi-contour front seats with dynamic and massage function		432	○	○	○	●	●	●	1,450.00	1,740.00
Front Seat Memory package Additional four-way electric lumbar support for front passenger seat Front seats, luxury front head restraints, steering column and exterior door mirrors – electrically adjustable with memory	Standard on S 500 L	P64	○	○	●	●	●	●	416.67	500.00



Item	Notes		SE L	AMG Line	S 500 e AMG Line L	S 600 AMG Line L	Mercedes-AMG S 63	Mercedes-AMG S 65	Basic RRP excl. VAT (£)	Total RRP incl. VAT (£)
<b>Comfort (continued)</b>										
Individual Rear Seats package Backrest angle adjustable up to 37° Comfort-ventilated rear seats Electrically adjustable rear seats with memory function Individual rear seats and folding rear tables Luxury rear head restraints with additional comfort cushion Stowage compartment with two 12V sockets Temperature-controlled cup holders (2)	Long wheelbase models only. Not in conjunction with Executive equipment line (code DA1). Reduces boot capacity by 30 litres	DA2	○	○	○	-	○	-	4,166.67	5,000.00
			-	-	-	○	-	○	2,416.67	2,900.00
KEYLESS-GO Comfort package The vehicle can be conveniently unlocked, started and locked with this access and drive authorisation system – simply by carrying the electronic key. The engine can be switched on and off by pressing the start/stop button in the ignition lock. The hands-free access allows hands-off, fully automatic opening and closing of the boot lid by performing a kicking movement under the rear bumper. The package includes handle recess illumination so that the door handles are easily visible in dark lighting conditions		P17	○	○	○	●	●	●	1,241.67	1,490.00
Rear Seat Comfort package Active multi-contour outer rear seats with dynamic and massage function Burmester® surround sound system (code 810) Rear seat entertainment system (code P46)	The Rear Seat Comfort package is available exclusively with either the Executive equipment line (code DA1) or the Individual Rear Seats package (code DA2). Also requires the Front Seat Memory package (code P64) and EASY ADJUST luxury front head restraints (code 439)	DA3	○	○	○	●	-	-	2,916.67	3,500.00
			-	-	-	-	○	●	1,975.00	2,370.00
	With Premium Plus equipment line (DP1)		○	○	-	-	-	-	2,495.83	2,995.00



Item	Notes		SE L	AMG Line	S 500 e AMG Line L	S 600 AMG Line L	Mercedes-AMG S 63	Mercedes-AMG S 65	Basic RRP excl. VAT (£)	Total RRP incl. VAT (£)
<b>Comfort (continued)</b>										
Rear Seat Reclining package EASY ADJUST luxury front head restraints (code 439) Front passenger seat with extended adjustment Reclining rear seat (up to 43.5°) behind front passenger and additional leg rest and footrest	Long wheelbase models only. Only in conjunction with Executive equipment line (code DA1) or Individual Rear Seats package (code DA2). Reduces boot capacity by 30 litres	DA4	○	○	○	●	○	●	1,250.00	1,500.00
Roller Blind package Electric roller blind for rear window and sun blinds for rear side windows	Included with Executive equipment line (code DA1)	P09	○	○	○	●	○	●	841.67	1,010.00
Warmth Comfort package Armrest heating in front and rear Heated multi-function steering wheel	Only in conjunction with heated rear seats (code 872) or Executive equipment line (code DA1) for short wheelbase models. Not available with dark brown eucalyptus wood trim (code 734). Only in conjunction with 2-spoke multi-function wood- and leather-trimmed steering wheel (code 289) for SE L or 3-spoke wood- and nappa leather-trimmed AMG sports steering wheel (code 314) for AMG Line	P69	○	○	○	●	○	●	441.67	530.00
Ashtray and cigarette lighter	Replaces stowage compartment and 12V socket	301	○	○	○	-	○	-	66.67	80.00
			-	-	-	○	-	○	no-cost option	
Closing aid for doors and boot lid	Included with Executive equipment line (code DA1), standard on S 500 L	883	○	○	●	●	-	-	508.33	610.00
EASY ADJUST luxury front head restraints	Only in conjunction with Front Seat Memory package (code P64), unless ordered as part of Rear Seat Reclining package (code DA4)	439	○	○	○	●	○	●	216.67	260.00
Electric panoramic glass sunroof		413	○	○	○	●	●	●	1,191.67	1,430.00
Front seats – comfort-ventilated, includes seat heating and cooling		401	○	○	○	●	○	●	550.00	660.00
Garage door opener – integrated in rear-view mirror For questions regarding compatibility please visit <a href="http://www.homelink.com">www.homelink.com</a>		231	○	○	○	●	○	-	191.67	230.00





Item	Notes		SE L	AMG Line	S 500 e AMG Line L	S 600 AMG Line L	Mercedes-AMG S 63	Mercedes-AMG S 65	Basic RRP excl. VAT (£)	Total RRP incl. VAT (£)
<b>Comfort (continued)</b>										
Heated windscreen	Only in conjunction with head-up display (code 463). Not in conjunction with TV tuner (code 865)	597	○	○	○	-	-	-	508.33	610.00
			-	-	-	○	-		366.67	440.00
	S 500 L and S 500 e		-	○	○	-	-	-	366.67	440.00
Infrared-reflective, noise-insulating glass all round	Standard on S 500 L	596	○	○	●	-	●	-	983.33	1,180.00
	In conjunction with Night View Assist Plus (code 610)		○	○	-	●	-	●	841.67	1,010.00
Panoramic roof with MAGIC SKY CONTROL – switchable transparency The large panoramic roof changes from dark to transparent or vice versa within a few seconds. In its tinted state it substantially reduces heating up of the vehicle interior		398	-	○	○	-	-	-	2,495.83	2,995.00
			-	-	-	○	○	○	1,304.17	1,565.00
Refrigerated compartment behind rear armrest	Reduces boot capacity by 40 litres	308	○	○	-	○	○	○	941.67	1,130.00
THERMOTRONIC – luxury automatic climate control, rear	Included with Executive equipment line (code DA1)	582	○	○	○	●	○	●	975.00	1,170.00
<b>Steering</b>										
Steering wheel – 2-spoke black designo leather/DINAMICA microfibre-trimmed AMG performance steering wheel		281	-	-	-	-	○	○	350.00	420.00
Steering wheel – 2-spoke multi-function wood- and leather-trimmed steering wheel	Only in conjunction with wood trims (code 729 or 731) or designo wood trims (code 727, H06, H10 or H21)	289	○	-	-	-	-	-	533.33	640.00
Steering wheel – 3-spoke wood- and nappa leather-trimmed AMG sports steering wheel 12 buttons, decorative stitching and silver-coloured aluminium gearshift paddles	Only in conjunction with wood trims (code 729 or 731) or designo wood trims (code 727, H06, H10 or H21)	314	-	○	○	●	○	○	525.00	630.00



Item	Notes		SE L	AMG Line	S 500 e AMG Line L	S 600 AMG Line L	Mercedes-AMG S 63	Mercedes-AMG S 65	Basic RRP excl. VAT (£)	Total RRP incl. VAT (£)
<b>Safety and Assistance Systems</b>										
Driving Assistance package Active Blind Spot Assist, Active Lane Keeping Assist, BAS PLUS with Cross-Traffic Assist, DISTRONIC PLUS with Steer Assist and Stop&Go Pilot, PRE-SAFE® Brake and PRE-SAFE® PLUS		P20	○	○	○	●	●	●	1,412.50	1,695.00
Intelligent Rear Seat Belts package Illuminated seat belt buckle extenders facilitate seat belt fastening on outer rear seats Inflatable three-point seat belts with integrated belt bags on outer seats	Only in conjunction with Executive equipment line (code DA1) or Individual Rear Seats package (code DA2)	P36	○	○	○	●	○	●	829.17	995.00
Night View Assist Plus With early detection of people and large animals in the dark, including spotlight function and windscreen with heat and noise-insulating and infrared-reflecting glass		610	○	○	-	●	-	-	1,875.00	2,250.00
	S 500 L and Mercedes-AMG		-	○	○	-	○	●	1,733.33	2,080.00



Item	Notes		SEL	AMG Line	S 500 e AMG Line L	S 600 AMG Line L	Mercedes-AMG S 63	Mercedes-AMG S 65	Basic RRP excl. VAT (£)	Total RRP incl. VAT (£)
<b>Communications and In-Car Entertainment</b>										
6-disc changer	Replaces standard single-disc changer	814	○	○	○	●	●	●	216.67	260.00
Burmester® surround sound system 13 speakers and 9-channel DSP amplifier with total output of 590 W. Includes voice amplification system which makes it easier to communicate with the rear passengers from the front. The two microphones in the interior mirror are also used to pick up speech for the hands-free telephone system. These signals are then discreetly amplified depending on the amount of driving noise, and continuously adjusted for the speaker's volume and the ambient noise level	Not in conjunction with Burmester® high-end 3D surround system (code 811). Included with Rear Seat Comfort package (code DA3)	810	○	○	○	-	●	-	941.67	1,130.00
Burmester® high-end 3D surround sound system 24 speakers and 24-channel amplifier with total output of 1,540 W. Includes voice amplification system which makes it easier to communicate with the rear passengers from the front. The two microphones in the interior mirror are also used to pick up speech for the hands-free telephone system. These signals are then discreetly amplified depending on the amount of driving noise, and continuously adjusted for the speaker's volume and the ambient noise level	Only in conjunction with Roller Blind package (code P09) with electric panoramic glass sunroof (code 413). Reduces luggage capacity by 40 litres. Not in conjunction with Burmester® surround sound system (code 810)	811	○	○	○	●	-	●	5,358.33	6,430.00
	Additionally in conjunction with Rear Seat Comfort package (code DA3)		○	○	○	-	○	-	4,416.67	5,300.00
	Only in conjunction with Roller Blind package (code P09). Reduces luggage capacity by 40 litres		-	-	-	-	○	-	4,416.67	5,300.00
Head-up display Virtual colour image (21×7 cm) showing information such as vehicle speed directly in driver's field of vision		463	○	○	-	-	-	-	1,025.00	1,230.00
	S 500 L and Mercedes-AMG		-	○	○	●	○	●	883.33	1,060.00
Rear seat entertainment system Two 10-inch screens on rear seat backrests, DVD player, two sets of wireless headphones and remote control for COMAND Online system	Only in conjunction with Burmester® or Burmester® high-end 3D surround sound systems (code 810 or 811) and EASY ADJUST luxury front head restraints (code 439) and Front Seat Memory package (code P64). Included with Rear Seat Comfort package (code DA3)	P64	○	○	○	●	○	●	2,041.67	2,450.00



Item	Notes	SEL	AMG Line	S 500 e AMG Line L	S 600 AMG Line L	Mercedes-AMG S 63	Mercedes-AMG S 65	Basic RRP excl. VAT (£)	Total RRP incl. VAT (£)	
<b>Communications and In-Car Entertainment (continued)</b>										
Rear seat telephony Handset with touchscreen and charger cradle, accommodated in the rear armrest or in the centre console in the rear with the Individual Rear Seats package Call transfer from the rear to the front and vice versa possible LTE-compatible aerial	Only in conjunction Rear seat entertainment system (code P46), Front Seat Memory package (P64), EASY ADJUST luxury front head restraints (439), either Burmester® or Burmester® high-end 3D surround sound systems (code 810 or 811), and either Executive equipment line (code DA1) or Individual Rear Seats package (code DA2).	856	○	○	○	●	○	●	803.33	<b>970.00</b>
Remote control for COMAND Online system		816	○	○	○	-	○	-	133.33	<b>160.00</b>
SPLITVIEW for COMAND Online system Allows different content to be displayed for driver and passenger		867	○	○	○	●	○	●	683.33	<b>820.00</b>
TV tuner – with digital reception capabilities		865	○	○	○	●	○	●	925.00	<b>1,110.00</b>
Universal Telephony package in armrest with universal interface for universal cradle, extended telephone functionality, charging function and LTE-compatible exterior aerial for optimum reception Smartphones can be conveniently connected to the onboard hands-free system via a universal interface in the armrest. For this, the smartphone is simply inserted into the universal smartphone cradle. This can be connected to the interface with a click within seconds. The use of the LTE-compatible exterior aerial ensures optimum reception and transmission. In addition the battery can be charged. The smartphone is conveniently operated using the onboard system. Access to the phone's internal memory is also possible in this way		386	○	○	○	●	○	●	341.67	<b>410.00</b>



> View offers



Book a > test drive > AMG test drive



> Find a Retailer



> View the Range Guide

Optional equipment

Item	Notes	SE L	AMG Line	S 500 e AMG Line L	S 600 AMG Line L	Mercedes-AMG S 63	Mercedes-AMG S 65	Basic RRP excl. VAT (£)	Total RRP incl. VAT (£)	
<b>Service Package</b>										
Service Care Service Care allows you to spread the cost of servicing your new car in the Mercedes-Benz Retailer network. Taking out a Service Care plan ensures your servicing needs are taken care of by fully trained Mercedes-Benz Technicians with the added benefit of a Mercedes-Benz service history	Price is based on a monthly rate. Example given is for two services taken over 24 months or three services over 36 months. Further payment options are available. New Service Care prices apply only to vehicles up to 12 months old prior to first service. Prices effective from 3 May 2016	1	○	○	○	○	-	-	34.17	41.00
			-	-	-	-	○	○	37.50	45.00





> View offers



Book a > test drive > AMG test drive



> Find a Retailer



> View the Range Guide

## Genuine Accessories

We've developed a range of Accessories you can add to help personalise and enhance your S-Class. Your local Mercedes-Benz Retailer can advise on fitting costs of Accessories, where applicable. Further information on our full range of Genuine Accessories can be found on the Mercedes-Benz UK website.



### 01 | Luggage net, floor of load compartment

Prevents lightweight objects from sliding around during your journey.

Basic RRP £48.33 (excl. VAT) **Total RRP £58.00 (incl. VAT)**



### 02 | Coat hanger, on head restraint

It's easy to arrive looking smart: the sturdy coat hanger allows you to hang up items of clothing on board. Rounded ends protect the fabric. Easy to secure in place behind the head restraint and to remove.

Basic RRP £55.50 (excl. VAT) **Total RRP £66.60 (incl. VAT)**



03

### 03 | Flacon perfume atomiser

The interior of the vehicle can be fragranced to suit your personal preferences. There are four high-quality fragrances to choose from: DOWNTOWN, NIGHTLIFE, FREESIDE and SPORTS. (Optional extra AIR BALANCE package required.)

Basic RRP £45.83 (excl. VAT) **Total RRP £55.00 (incl. VAT)**



04

### 04 | Exterior Car Care Kit

The Mercedes-Benz Exterior Car Care Kit is a four-piece collection to keep the exterior of your car looking like it's come straight from the showroom. The bag contains car shampoo, wheel cleaner, sponge and polishing cloth.

Basic RRP £20.83 (excl. VAT) **Total RRP £25.00 (incl. VAT)**



05

### 05 | Interior Car Care Kit

The Mercedes-Benz Interior Car Care Kit is a four-piece collection enabling you to maintain a spotless showroom finish inside your car. The bag contains cabin care spray, interior glass cleaner, interior glass sponge and car cloth.

Basic RRP £20.83 (excl. VAT) **Total RRP £25.00 (incl. VAT)**



# Colours and materials

## Metallic paints

### Standard



183 magnetite black



890 cavansite blue



989 emerald green



197 obsidian black



897 ruby black



992 selenite grey



775 iridium silver



988 diamond silver



998 anthracite blue

## designo paints

### Additional-cost option



033 designo black mocha metallic



044 designo allanite grey magno

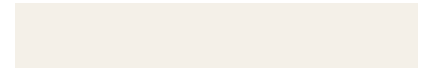

049 designo cashmere white magno

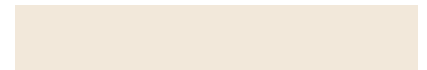

799 designo diamond white bright



**Leather**

Standard (SE and AMG Line)



201 black



205 silk beige/espresso brown



208 crystal grey/seashell grey

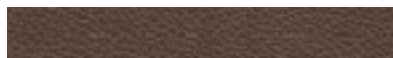

214 nut brown/black

**Nappa leather**

Optional; standard on Mercedes-AMG S 63



801/851<sup>1</sup> black

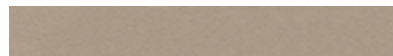

805/855<sup>1</sup> silk beige/espresso brown



808/858<sup>1</sup> crystal grey/seashell grey



814/864<sup>1</sup> nut brown/black

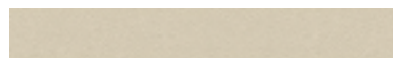

815/865<sup>1</sup> porcelain/black

**Exclusive nappa leather**

Optional; standard on S 600 L and Mercedes-AMG S 65<sup>2</sup>



501/561<sup>3</sup> black

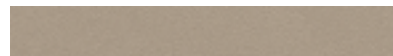

505/565<sup>3</sup> silk beige/espresso brown



508/568<sup>3</sup> crystal grey/seashell grey



514/584<sup>3</sup> nut brown/black

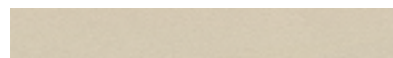

515/585<sup>3</sup> porcelain/black

**designo nappa leather**

Optional

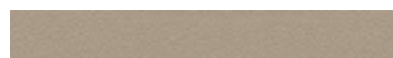

P62 designo silk beige/titanium grey pearl

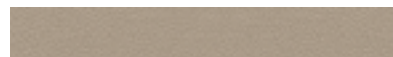

P87 designo silk beige/satin red pearl

**Trim**

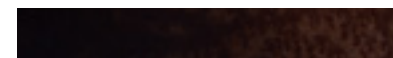

727 designo brown sunburst myrtle wood<sup>4</sup>

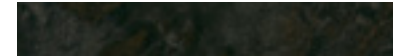

729 black poplar wood<sup>5</sup>



731 brown burr walnut wood<sup>6</sup>



734 high-gloss dark brown eucalyptus wood<sup>7</sup>

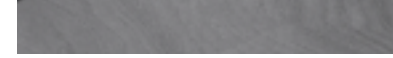

H06 designo metallised ash wood<sup>4</sup>



H10 AMG carbon fibre/black piano lacquer<sup>4</sup>



H16 designo black piano lacquer flowing lines<sup>4</sup>



H21 designo black piano lacquer<sup>4</sup>

<sup>1</sup>Upholstery codes for Mercedes-AMG S 63 <sup>2</sup>Included with Exclusive Nappa Leather package (code P34) <sup>3</sup>Upholstery codes for Mercedes-AMG S 63 and Mercedes-AMG S 65 <sup>4</sup>Optional with Exclusive Nappa Leather package (code P34)

<sup>5</sup>Standard on AMG Line and Mercedes-AMG S 63, optional on SE and Mercedes-AMG S 65 <sup>6</sup>Optional <sup>7</sup>Standard on SE



# Trim and upholstery combinations

	Leather/nappa leather/Exclusive nappa leather				Nappa leather/ Exclusive nappa leather
	black (201/801/851/501/561)	silk beige/espresso brown (205/805/855/505/565)	crystal grey/seashell grey (208/808/858/508/568)	nut brown/black (214/814/864/514/584)	porcelain/black (815/865/515/585)
<b>Dashboard</b>					
Steering wheel	black	silk beige	crystal grey	black	black
Upper dashboard trim	black	espresso brown	seashell grey	black	black
Centre dashboard trim	black	silk beige	crystal grey	nut brown	porcelain
Lower dashboard trim	black	silk beige	crystal grey	black	black
<b>Seats</b>					
Seat cushion centre section	black	silk beige	crystal grey	nut brown	porcelain
Side bolster trim	black	silk beige	crystal grey	nut brown	porcelain
Head restraint	black	silk beige	crystal grey	nut brown	porcelain
Contrast stitching	black	silk beige/espresso brown	crystal grey/seashell grey	nut brown/black	porcelain/black
Seat belt	black	silk beige	crystal grey	nut brown	black
<b>Doors</b>					
Door trim at beltline	black	espresso brown	seashell grey	black	black
Door centre panel	black	silk beige	crystal grey	nut brown	porcelain
Lower door trim	black	silk beige	crystal grey	black	black
<b>Roof lining</b>	black	porcelain	crystal grey	black	black
<b>Parcel shelf</b>	black	espresso brown	seashell grey	black	black
<b>Floor covering</b>					
Front and rear	black	silk beige	crystal grey	black	black
Boot	black	black	black	black	black





# Combination options

Leather/nappa leather/Exclusive nappa leather		Metallic paints										designo paints				
		Standard	183 magnetite black	197 obsidian black	775 iridium silver	890 cavansite blue	897 ruby black	988 diamond silver	989 emerald green	992 selenite grey	998 anthracite blue	Additional-cost option	033 designo black mocha metallic	044 designo allanite grey magno	049 designo cashmere white magno	799 designo diamond white bright
	black	●	●	●	●	●	●	●	●	●		●	●	●	●	
	silk beige/espreso brown	●	●	○	●	●	△	●	○	●		●	●	●	●	
	crystal grey/seashell grey	●	●	●	●	●	●	○	●	●		●	●	●	●	
	nut brown/black	●	●	●	●	△	●	●	●	●		●	●	●	●	
	porcelain/black	●	●	○	●	●	○	●	●	●		●	●	●	●	



# Technical data

	Diesel hybrid	Diesel engine	Petrol hybrid	Petrol engines			
Model	S 300 h L	S 350 d/S 350 d L	S 500 e L	S 500 L	S 600 L	Mercedes-AMG S 63	Mercedes-AMG S 65
<b>Engine</b>							
Total displacement	cc 2,143	2,987	2,996	4,663	5,980	5,461	5,980
Arrangement/cylinders/valves	in-line/4/16	V/6/24	V/6/24	V/8/32	V/12/36	V/8/32	V/12/36
Power <sup>1</sup>	hp (kW) at rpm						
Combustion engine	204 (150)/3,800	258 (190)/3,600	333 (245)/5,250-6,000	455 (335)/5,250-5,500	530 (390)/4,900-5,300	585 (430)/5,500	630 (463)/4,800-5,400
Electric motor	27 (20)/1,800	-	116 (85)/3,500	-	-	-	-
System output	-	-	442 (325)/5,000	-	-	-	-
Torque <sup>1</sup>	Nm at rpm						
Combustion engine	500/1,600-1,800	620/1,600-2,400	480/1,600-4,000	700/1,800-3,500	830/1,900-4,000	900/2,250-3,750	1,000/2,300-4,300
Electric motor	250/0-1,000	-	340/0-2,400	-	-	-	-
System output	-	-	650/-	-	-	-	-
<b>Transmission</b>							
7G-TRONIC PLUS 7-speed automatic	●	-	●	-	●	-	-
9G-TRONIC PLUS 9-speed automatic	-	●	-	●	-	-	-
AMG SPEEDSHIFT MCT 7-speed automatic sports transmission	-	-	-	-	-	●	-
AMG SPEEDSHIFT PLUS 7G-TRONIC 7-speed automatic transmission	-	-	-	-	-	-	●



Model	Diesel hybrid	Diesel engine	Petrol hybrid	Petrol engines			
	S300h L	S350d/S350d L	S500e L	S500 L	S600 L	Mercedes-AMG S 63	Mercedes-AMG S 65

**Performance**

Acceleration 0-62 mph [long]	sec	- [7.6]	6.8 [6.8]	- [5.2]	- [4.8]	- [4.6]	- [4.4]	- [4.3]
Top speed	mph	155 <sup>2</sup>	155 <sup>2</sup>	155 <sup>2</sup>	155 <sup>2</sup>	155 <sup>2</sup>	155 <sup>2</sup>	155 <sup>2</sup>

**Weights and capacities**

Kerb weight [long]	kg	- [2,035]	1,955 [1,975]	2,215 [-]	- [2,015]	- [2,185]	- [2,070]	- [2,250]
Perm. Gross Vehicle Weight [long]	kg	- [2,750]	2,655 [2,690]	2,825 [-]	- [2,730]	- [2,740]	- [2,700]	- [2,750]
Boot capacity	l	510	510	395	530	460	510	470
Fuel tank capacity/ of which reserve	l	70/8	70/8	70/8	80/8	80/8	80/10	80/12
Turning circle [long]	m	- [12.3]	11.9 [12.3]	- [12.3]	- [12.3]	- [12.3]	- [12.3]	- [12.3]

**Fuel consumption<sup>3,4</sup>**

mpg

Urban [long]	- [60.1]	42.8 [42.2]	- [-]	- [24.6]	- [16.9]	- [20.5]	- [16.5]
Extra-urban <sup>5</sup> [long]	- [61.4]	57.7 [57.7]	- [-]	- [42.8]	- [32.8]	- [35.8]	- [32.8]
Combined [long]	- [61.4]	50.4 [52.3]	- [100.9]*	- [33.6]	- [24.6]	- [28.0]	- [23.7]



Model	Diesel hybrid	Diesel engine	Petrol hybrid	Petrol engines			
	S 300 h L	S 350 d/S 350 d L	S 500 e L	S 500 L	S 600 L	Mercedes-AMG S 63	Mercedes-AMG S 65

**CO<sub>2</sub> emissions<sup>4</sup>** g/km

Emissions standard	EU6	EU6	EU6	EU6	EU6	EU6	EU6
18" alloy wheels – code 01R [long]	- [-]	- [141]	- [-]	- [-]	- [-]	- [-]	- [-]
19" alloy wheels – code R17 [long]	- [-]	- [148]	- [-]	- [-]	- [-]	- [-]	- [-]
19" alloy wheels – code 793 [long]	- [120]	146 [148]	- [65]	- [196]	- [268]	- [-]	- [-]
19" alloy wheels – code 788 [long]	- [-]	- [-]	- [-]	- [-]	- [-]	- [237]	- [279]
20" alloy wheels – code 769 [long]	- [126]	155 [157]	- [65]	- [206]	- [268]	- [-]	- [-]
20" alloy wheels – code 647 [long]	- [-]	- [-]	- [-]	- [-]	- [-]	- [237]	- [279]
20" alloy wheels – code 648 [long]	- [-]	- [-]	- [-]	- [-]	- [-]	- [237]	- [279]
20" alloy wheels – code 696 [long]	- [-]	- [-]	- [-]	- [-]	- [-]	- [-]	- [tba]

**Insurance**

Group rating [long] – SE – AMG Line	- [-] - [47A]	- [49A] 49A [50A]	- [-] - [50A]	- [-] - [50A]	- [-] - [50A]	- [-] - [50A]	- [-] - [50A]
--	------------------	----------------------	------------------	------------------	------------------	------------------	------------------

Insurance ratings may vary depending on model line and specification. Please refer to <http://www.thatcham.org/abigrouprating/> for further details

<sup>1</sup>Figures according to Directive 80/1269/EEC in the currently applicable version <sup>2</sup>Electronically limited <sup>3</sup>All figures are based on a standard specification with the smallest tyre size

<sup>4</sup>The choice of wheels may affect CO<sub>2</sub> emissions and corresponding Road Fund Licence <sup>5</sup>EUDC: extra-urban driving cycle. Testing procedures adhere to EU Directive 93/116

\*The manufacturer's stated fuel consumption figures are based on the legally prescribed NEDC test cycle, which is performed in a laboratory. These are the only figures we are allowed to publish.

It is common that differences occur in real driving conditions compared with these certified laboratory values. They result primarily from conditions different from the legally-prescribed laboratory conditions, for example when ambient temperatures differ (the weather is hot, cold, windy, wet), the vehicle is operated under different loads and many other factors.

For several years, Mercedes-Benz has fully and actively supported the early introduction of the WLTP (Worldwide Harmonised Light Vehicles Test Procedure) and the measuring procedure for Real Driving Emissions (RDE). This procedure is designed to supersede the NEDC, with the goal of bringing standardised and real-world consumption closer together.



> View offers



Book a > test drive > AMG test drive



> Find a Retailer



> View the Range Guide

Standard wheelbase

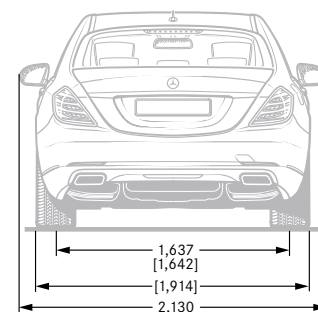
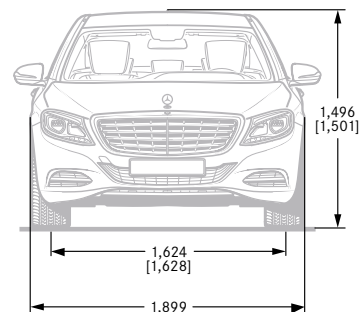
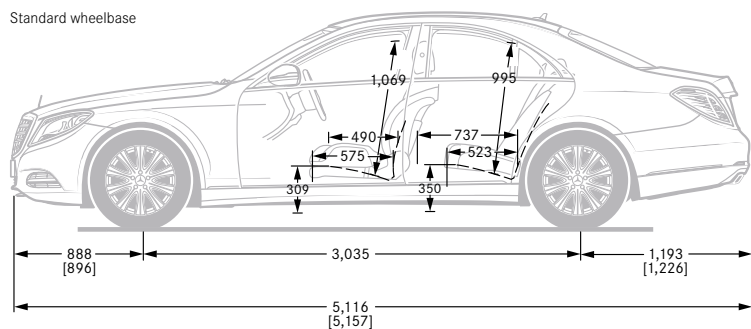

Long wheelbase

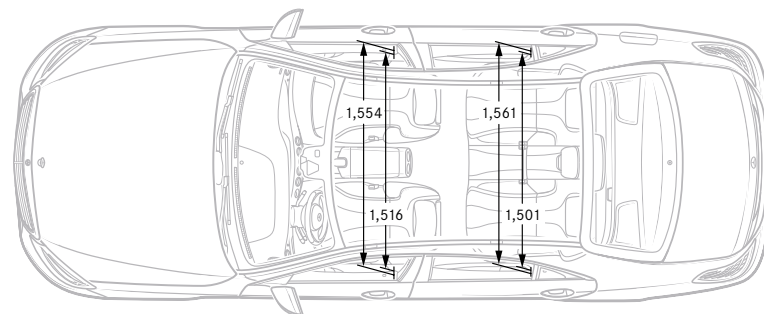
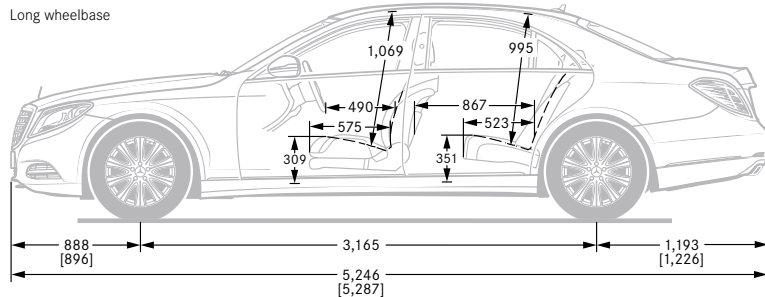

Figures in square brackets relate to Mercedes-AMG models.

The figures on pages 69-72 are correct at time of publication. Please refer to the government website for latest data - <http://carfueldata.direct.gov.uk/>

All measurements in millimetres. The dimensions shown are mean values and apply to standard-specification, unladen vehicles





# Road Fund Licence



All road vehicle registrations are subject to Vehicle Excise Duty (Road Fund Licence), which varies in accordance with the vehicle's CO<sub>2</sub> emissions. A first year rate of Vehicle Excise Duty applies to new cars on their first year of registration. For the second and subsequent years a standard rate for each taxation band will apply.<sup>1</sup> The table below shows the bands (A–M) created by the DVLA and the corresponding Road Fund Licence. CO<sub>2</sub> emissions are listed in the technical data on page 71 and the relevant Excise Duty is reflected in the on-the-road prices on page 11.

Band	CO <sub>2</sub> emissions	Petrol/Diesel		Electric/Hybrid	
		First year rate (£)	Standard rate (£)	First year rate (£)	Standard rate (£)
A	up to 100 g/km	0.00	0.00	0.00	0.00
B	101–110 g/km	0.00	20.00	0.00	10.00
C	111–120 g/km	0.00	30.00	0.00	20.00
D	121–130 g/km	0.00	110.00	0.00	100.00
E	131–140 g/km	130.00	130.00	120.00	120.00
F	141–150 g/km	145.00	145.00	135.00	135.00
G	151–165 g/km	185.00	185.00	175.00	175.00
H	166–175 g/km	300.00	210.00	290.00	200.00
I	176–185 g/km	355.00	230.00	345.00	220.00
J	186–200 g/km	500.00	270.00	490.00	260.00
K	201–225 g/km	650.00	295.00	640.00	285.00
L	226–255 g/km	885.00	500.00	875.00	490.00
M	over 255 g/km	1,120.00	515.00	1,110.00	505.00

<sup>1</sup>For further information on vehicle taxation please refer to <http://carfueldata.direct.gov.uk/>



# Services and insurance

## Mercedes-Benz Service Care

We believe that servicing costs should be as flexible and affordable as possible for your S-Class, which is why we offer Service Care, an easy way to budget for all your servicing costs. It spreads your bills into manageable payments based on whether you have a new or used Mercedes-Benz.

With Service Care we guarantee the price of parts and labour for up to four services and safeguard against further inflation. It also covers the cost of all recommended service items including brake fluid, spark plugs, air filters, fuel filters and screen wash.

You can choose either to add your servicing costs into your monthly spend or pay the full amount in a one-off payment, giving you peace of mind that they are taken care of for the period of the plan.

To receive a personalised Service Care plan recommendation visit the Service Care Calculator at [servicecarerates.mercedes-benz.co.uk](http://servicecarerates.mercedes-benz.co.uk)

## Warranty and breakdown cover

Every Mercedes-Benz comes with a three-year unlimited mileage warranty against manufacturing or material defects<sup>1</sup> and up to 30 years warranty against perforation due to corrosion from the inside out<sup>2</sup>. What's more, it's also covered by Mercedes-Benz Roadside Assistance – a unique package comprising up to 30 years pan-European breakdown assistance<sup>2</sup>.

The following key components of the S 500 e AMG Line L are covered for six years or 62,000 miles (whichever comes sooner):

- High-voltage battery
- Electric motor
- Power electronics

## Insurance

Since our name is synonymous with reliability, who better to trust with your motor insurance? Mercedes-Benz Insurance provides a motor insurance policy specifically designed to give you the cover you would expect from Mercedes-Benz. For a motor insurance quotation, call **0345 600 2180**.\*

<sup>1</sup>Applies to vehicles sold by Mercedes-Benz in the UK to its franchised Retailers <sup>2</sup>Subject to full Terms and Conditions, dependent on date of registration, available upon request Mercedes-Benz Motor Insurance is underwritten by Aviva Insurance UK Limited. Credit provided, subject to status, by Mercedes-Benz Financial Services UK Ltd, MK15 8BA \*For joint protection, calls may be recorded and/or monitored. All calls charged at local rate. We may decline to quote in some circumstances



> View offers



Book a > test drive > AMG test drive



> Find a Retailer



> View the Range Guide

# The Mercedes that thinks and acts for you.

## Imagine if...

### ...you could connect with your Mercedes-Benz?

With Mercedes me connect, you can; with Remote Online services<sup>1</sup> that include trip planning, maintenance management and vehicle tracking, plus more.

Getting connected is easy. Just set up your Mercedes me account and get in touch with your Mercedes-Benz Retailer to connect your vehicle to your profile to access your Mercedes me connect services.

### ...you knew beforehand that you need to stop for fuel?

Simply check the fuel level and mileage range from your phone wherever you are. You can also check tyre pressure and washer fluid level. (For electric cars, you can check battery charge state.)

### ...your Mercedes could tell you where it's parked?

You no longer need to ask yourself where you left your car; with Mercedes me connect you can locate your car from your smartphone or tablet within a mile radius.



1. PARKED VEHICLE LOCATOR  
2. VEHICLE TRACKER

3. REMOTE RETRIEVAL OF VEHICLE STATUS  
4. PRE-ENTRY CLIMATE CONTROL FOR ELECTRIC DRIVE AND PLUG-IN HYBRID



> View offers



Book a > test drive > AMG test drive



> Find a Retailer



> View the Range Guide

### ...you could lock your Mercedes, even if you're miles away?

The uncertainty of whether you've forgotten to lock the car is only human. To make sure your Mercedes-Benz is safe and secure, you can simply lock the car remotely via your PC/Mac, tablet or smartphone.

### ...your Mercedes told you when your service is due?

Being connected means essential data is constantly sent to your Mercedes-Benz Retailer so they know when it is time for a service. Your Retailer can then contact you with a tailor-made service quote.

### ...your Retailer already knows which parts need replacing?

As surprising as this sounds, with teliagnostics your Retailer can recognise remotely if certain parts are due for replacement, contacting you to book an appointment and making sure the relevant parts are in stock when you arrive, getting you back on the road as quickly as possible.

### ...you could just push a button to deal with a breakdown?

Should your car break down, with a simple press of the button everything is taken care of – from breakdown assistance to vehicle recovery.

### ...your Mercedes called for help?

Your Mercedes comes with an SOS button. Press it if you need urgent help and you will be contacted by the emergency response centre.<sup>2</sup> In the event of an accident where airbags or seatbelt tensioners have been activated, a call is placed automatically. Your GPS position is sent to the response teams to initiate rescue efforts.<sup>3</sup>

### The Mercedes that thinks and acts for you.

Contact your Retailer to get connected, or go to [www.mercedes.me](http://www.mercedes.me) for more details.

<sup>1</sup>This is available as an option in conjunction with Audio 20 CD, and standard with COMAND Online. Remote Online is standard with electric drive and plug-in hybrid. Use of the Remote Online equipment option is limited to three years from first registration of the vehicle and can then be extended at extra cost.

<sup>2</sup>A call is placed via the car's sim card, rather than the customer relying on their mobile phone.

<sup>3</sup>This feature is still available to customers without Mercedes me connect services. The customer is not required to accept the terms and conditions on the portal to activate this feature. For all other features the customer will have to accept terms and conditions on the portal to activate them.



# Mercedes-Benz Finance

## Why should you finance with Mercedes-Benz?

At Mercedes-Benz we believe a great driving experience should be matched by an equally great ownership experience. That is why we put just as much thought, time and effort into designing our finance options, our service plans and our insurance cover as we do into our vehicles.

We are not in the business of simply providing a loan to fund the purchase of your dream vehicle. We look on it as a journey that we take with you, from the moment you choose your new Mercedes-Benz, to helping you in choosing your next one.

If you would like to find out more about any of our current offers, simply call into your local Mercedes-Benz Retailer where one of our Business Managers will be more than happy to talk you through anything you need to know.

## Helping you find the right solution.

You should find our finance packages are more convenient than a traditional personal loan because:

- Funds are immediately available – no waiting for cheques or loans to clear.
- There is no security required – either against your home or other assets.
- We have clear and transparent rates – the APR we quote is the APR you get.
- We have friendly Business Managers – experts in vehicle finance who can talk you through all of your plans in detail.

One of our most popular finance products is Mercedes-Benz Agility (our Personal Contract Purchase product). We also offer Contract Hire, Operating Lease and Hire Purchase solutions. If you would like to find out more about these speak to your Retailer or visit [www.mercedes-benz.co.uk/fandi](http://www.mercedes-benz.co.uk/fandi).

## Mercedes-Benz Agility (our PCP product).

At the start of an Agility agreement, you put down a deposit and decide the term of your agreement and your annual mileage. You will be advised of the Guaranteed Future Value, which offers you the reassurance of knowing exactly what you will need to pay to own the vehicle outright in the future (this is known as the Optional Purchase Payment).

Throughout your agreement you simply pay your agreed monthly payments and when the agreement comes to an end you either purchase, hand back or part-exchange your vehicle.





### Agility features:

- Fixed regular payments mean you can easily budget.
- Payments are based only on a proportion of the vehicle's value, keeping your monthly payments lower.
- Our Guaranteed Future Value avoids the risk of unplanned depreciation of your vehicle.
- You defer your ownership decision until the end of the agreement.

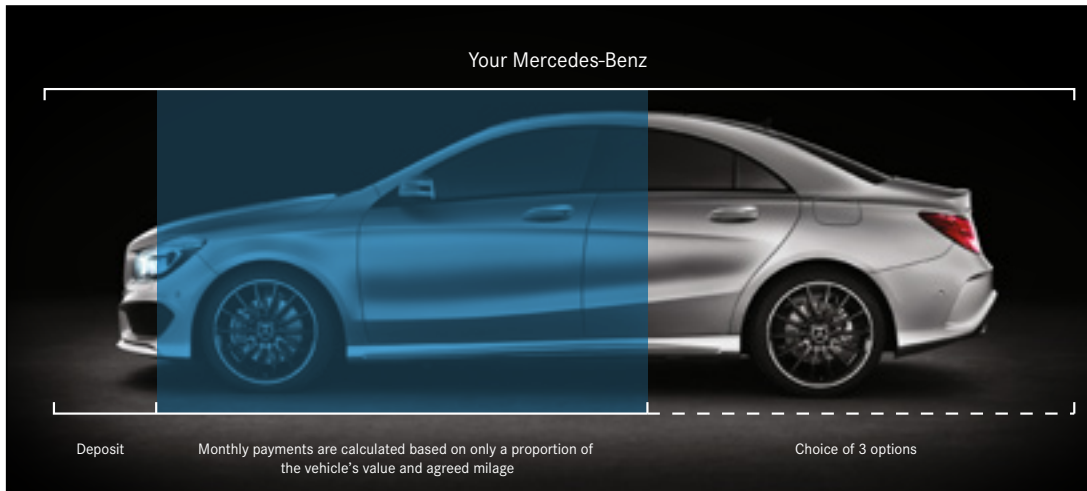

### At the end of your agreement you have three options to choose from.

#### Option 1: Purchase your Mercedes-Benz.

Purchase your Mercedes-Benz by paying the Optional Purchase Payment and Purchase Activation Fee.<sup>1</sup> This will complete the purchase of your Mercedes-Benz, leaving you free to simply enjoy your vehicle.

#### Option 2: Hand back your Mercedes-Benz.

If you decide to return your vehicle to us, it must be in line with our Vehicle Return Standards,\* as vehicle condition, excess mileage and other charges may be payable.

#### Option 3: Part-Exchange for a new vehicle.

Purchase your Mercedes-Benz by paying the Optional Purchase Payment and Purchase Activation Fee.<sup>1</sup> This will complete the purchase of your Mercedes-Benz, leaving you free to part-exchange for a new vehicle.

<sup>1</sup>Please note the 'Purchase Activation Fee' of £10 will be debited from your account \*To find out more information about our Vehicle Return Standards please visit <http://mercedes-benz.co.uk/vrs>





# Chargemaster Homecharge – simple steps to effortless charging

When you purchase a Mercedes-Benz plug-in vehicle we recommend Chargemaster, our preferred charging partner. The 3.6 kW Chargemaster Homecharge allows you to charge your electric car in just 2 hours.<sup>1</sup>

## Key benefits of the 3.6 kW Chargemaster Homecharge:

- 60% faster than a 13 A plug<sup>1</sup>
- Ergonomic styling, robust and weatherproof, for indoor or outdoor use
- Designed for users with a domestic address and off-street parking
- Available with £500 OLEV Electric Vehicle Homecharge Scheme (EVHS) Grant (for eligible customers only)<sup>2</sup>
- Key-controlled access for added security
- POLAR plus network card providing access to the UK’s largest public charging infrastructure, with over 5,000 charging points
- Three year product warranty included

HOMECHARGE 3.6 kW: **£279\*** inc. VAT & installation



## Simple steps to Chargemaster Homecharge:

- Fill in the application form at [www.chargemasterplc.com](http://www.chargemasterplc.com)
- Chargemaster will contact you to discuss your household electrics and arrange for specialist installation within two weeks

For further information please contact:

**[mercedes-benz@chargemasterplc.com](mailto:mercedes-benz@chargemasterplc.com)** or call **01582 399 412**



Chargemaster is the UK’s leading provider of domestic charging solutions, trusted by more than 50,000 users across the UK and Europe. Manufactured in the UK, Chargemaster offers a wide range of installation services, choice of power output, and flexible data and security options to suit your requirements.

<sup>1</sup>Based on 3.6 kW power output for plug-in hybrid vehicles

<sup>2</sup>The Chargemaster Homecharge £500 Grant (including VAT) is only available to customers who meet the criteria of the Office of Low Emission Vehicles (OLEV) and is provided and installed by Chargemaster plc. For full details and eligibility criteria for the OLEV EVHS Grant, see <https://www.gov.uk/government/publications/electric-vehicle-homecharge-scheme-guidance-for-customers-version-21>. For full Chargemaster Homecharge Terms & Conditions visit [https://chargemasterplc.com/terms\\_conditions](https://chargemasterplc.com/terms_conditions)

\*Price includes £500 OLEV EVHS Grant. Price correct at time of publication, subject to change



> View offers



Book a > test drive > AMG test drive



> Find a Retailer



> View the Range Guide

Follow us on the following social media channels:



<https://www.facebook.com/MercedesBenzUK>



<https://twitter.com/mercedesbenzUK>



<https://www.youtube.com/mercedesbenzUK>



<https://instagram.com/mercedesbenzUK>

Effective from 1 December 2016 Production. Information correct at time of publication.

Prices and specifications are subject to change without prior notice.

MBWV222PL/1216 MY 807

Mercedes-Benz UK Ltd, Tongwell, Milton Keynes, MK15 8BA [www.mercedes-benz.co.uk](http://www.mercedes-benz.co.uk)